



# Carmel

design by Studio V

Conference, Executive, Execu-Task,  
Jury Seating, Private Office



## Features

- High back chair & mid back chairs with single shell tilt mechanism & split shell synchro mechanism options
- Control Mechanisms: quick adjust advanced synchro, basic tilt or dynamic knee-tilt
- Via Seating’s comfort foam: a proprietary blend of high-density, injection-molded, closed-cell, cold-cured comfort foam
- Design for the Environment (DfE): Screened to the ANSI/BIFMA e3-2019 Annex B- List of Chemicals of Concern & CA Prop 65 List
- Sustainability: BIFMA LEVEL 2 certified & CLEAN AIR GOLD certified/certified low emitting
- Specify On: Spec It, CET, GSA (contract #GS-28F-005CA), Project Matrix, 2020 (“CAP/GIZA”) & KITS Collaborator

## Statement of Line



High back #6903



Mid back #6901



Jury chair #6901J



# Carmel





Mid & high back chairs #6901 & #6903  
GSA SIN# 33721



## 1. Starting Model

Part #	Price	Description
6901	<b>+\$1337</b>	Mid back
6903	<b>+\$1559</b>	High back

## 2. Control Mechanism



Part #	Price	Description
71C	<b>+\$0</b>	Standard basic conference tilt 
42C	<b>+\$165</b>	Dynamic knee-tilt 
67C	<b>+\$265</b>	Quick adjust advanced synchro 
67C-SS	<b>+\$391</b>	Quick adjust advanced synchro & seat depth 
67C-SS-FT	<b>+\$447</b>	Quick adjust advanced synchro, seat depth & forward tilt 

## 2a. Optional Height Adjustable





Part #	Price	Description
	<b>+\$0</b>	Standard fixed back
RB	<b>+\$205</b>	Adjustable ratchet back

Note 1: #RB is only available on controls #67C, #67C-SS & #67C-SS-FT.



## 3. Optional Arm

Part #	Price	Description
0A	<b>+\$0</b>	Standard armless 
51A	<b>+\$121</b>	Black 2-way up to 8-way adjustable arms 

## Optional Arm Continued



Part #	Price	Description
53A	<b>+\$205</b>	Polished 2-way up to 8-way adjustable arms 
80A	<b>+\$293</b>	Black "C" shape fixed arms 
90A	<b>+\$404</b>	Fully upholstered "C" shape fixed arms 
96A	<b>+\$225</b>	Black cantilever fixed arms 
97A	<b>+\$307</b>	Polished cantilever fixed arms with black armrest 

## 3a. Armrest

Part #	Price	Description
20S	<b>+\$0</b>	Standard fixed black armrest <sup>2</sup> 
20R	<b>+\$57</b>	4D black rotating armrest (back/forth, rotate left/right) <sup>2</sup> 

Note 2: #20S & #20R are available with arms #51A & #53A.

## 3b. Optional Arm Width Adjustment

Part #	Price	Description
	<b>+\$0</b>	Standard no arm width adjustment 
19AB	<b>+\$45</b>	Arm width adjustment bracket (in/out) <sup>3</sup> 

Note 3: #19AB are available with arms #51A & #53A.

# Carmel

Mid & high back chairs #6901 & #6903  
GSA SIN# 33721



## 3c. Arm #90A: + Textile Grade

Part #	Price	Description
GR A	+\$0	Grade A fabric, vinyl or leather
GR B	+\$2	Grade B fabric, vinyl or leather
GR 1	+\$4	Grade 1 fabric, vinyl or leather
COM	+\$4	Customer's Own Fabric or Vinyl
GR 2	+\$9	Grade 2 fabric, vinyl or leather
GR 3	+\$12	Grade 3 fabric, vinyl or leather
COL	+\$12	Customer's Own Leather
GR 4	+\$24	Grade 4 fabric, vinyl or leather
GR 5	+\$29	Grade 5 fabric, vinyl or leather
GR 6	+\$39	Grade 6 fabric, vinyl or leather
GR 7	+\$54	Grade 7 fabric, vinyl or leather
GR 8	+\$68	Grade 8 fabric, vinyl or leather

## 4. Base

Part #	Price	Description
18BB	+\$0	Standard black nylon low-profile 5-star swivel base 
18PB	+\$156	Polished aluminum low-profile 5-star swivel base 
18HB	+\$1000	Wood low-profile 5-star swivel base <sup>4</sup> 

Note 4: Base available on an extended lead time.

## 4a. Wood Base Finishes<sup>5</sup>

Part #	Price	Description
BWA	+\$0	Black walnut
CHE	+\$0	Cherry
CIN	+\$0	Cinnabar

Note 5: Wood finishes only available on base #18HB.

## 4b. Casters or Glides

Part #	Price	Description
16HP	+\$0	Standard black carpet casters for low-profile bases 
16SCG	+\$39	Grey-black all floor casters for low-profile bases 
16GL	+\$39	Black all floor glides for low-profile bases 

## 4c. Optional Safety Brake

Part #	Price	Description
SL1	+\$39	Reverse-locking, weight-activated, safety brake feature <sup>6</sup>

Note 6: #SL1 is available on casters #16HP & #16SCG.

## 5. Optional Adjustable Lumbar

Part #	Price	Description
12LUM	+\$156	Mechanical internal lumbar support 

## 6. Optional Diamond Stitch

Part #	Price	Description
EDS	+\$272	Executive diamond stitch thread pattern on the front top/headrest of the chair 

## 6A. Optional Emphasized Stitch

Part #	Price	Description
	+\$0	Thread is a clean tonal match
CTS	+\$0	Choice of thread color <sup>7</sup>

Note 7: Emphasized stitch is available with #EDS only.

# Carmel

Mid & high back chairs #6901 & #6903  
GSA SIN# 33721



## 6B. Thread Color

Part #	Price	Description
03	+\$0	Black
05	+\$0	Grey
04	+\$0	White
06	+\$0	Cream
07	+\$0	Chocolate
09	+\$0	Blue
08	+\$0	Red
10	+\$0	Yellow

## 7. Packaging

Part #	Price	Description
9FA	+\$0	Ships 95% assembled
FA	+\$98	Ships fully assembled in the box

## 8. Model: #6901: Textile

Part #	Price	Description
GR A	+\$0	Grade A fabric, vinyl or leather
GR B	+\$37	Grade B fabric, vinyl or leather
GR 1	+\$108	Grade 1 fabric, vinyl or leather
COM	+\$108	Customer's Own Fabric or Vinyl
GR 2	+\$163	Grade 2 fabric, vinyl or leather
GR 3	+\$255	Grade 3 fabric, vinyl or leather
COL	+\$255	Customer's Own Leather
GR 4	+\$368	Grade 4 fabric, vinyl or leather
GR 5	+\$494	Grade 5 fabric, vinyl or leather
GR 6	+\$660	Grade 6 fabric, vinyl or leather
GR 7	+\$858	Grade 7 fabric, vinyl or leather
GR 8	+\$1114	Grade 8 fabric, vinyl or leather

## or 8. Model #6903: Textile

Part #	Price	Description
GR A	+\$0	Grade A fabric, vinyl or leather
GR B	+\$45	Grade B fabric, vinyl or leather
GR 1	+\$117	Grade 1 fabric, vinyl or leather
COM	+\$117	Customer's Own Fabric or Vinyl
GR 2	+\$172	Grade 2 fabric, vinyl or leather
GR 3	+\$263	Grade 3 fabric, vinyl or leather
COL	+\$263	Customer's Own Leather
GR 4	+\$376	Grade 4 fabric, vinyl or leather
GR 5	+\$504	Grade 5 fabric, vinyl or leather
GR 6	+\$667	Grade 6 fabric, vinyl or leather
GR 7	+\$868	Grade 7 fabric, vinyl or leather
GR 8	+\$1121	Grade 8 fabric, vinyl or leather

## Build Model String

\_ \_ \_ \_ \_ \_ \_ \_ \_ \_ \_ \_ \_ \_ \_ \_  
 1 2 2A 3 3A 3B 3C 4 4A 4B 4C 5 6  
 \_ \_ \_ \_ \_  
 6A 6B 7 8

Example:

6901-71C-0A-18BB-16HP-9FA-GR A (ORIGIN JET)



Quoting is easiest with Via's online quote software that renders & prices your model in real time. Scan the QR code or visit <https://viaseating.com/spec-it/#/carmel>

# Carmel

Jury chair #6901J  
GSA SIN# 33721



## 1. Starting Model

Part #	Price	Description
6901J-71C-20JRY	<b>+\$1752</b>	Jury chair using a mid back, a basic conference tilt & a 12" diameter, die-casted, aluminum black jury base

## 2. Optional Arm

Part #	Price	Description	
0A	<b>+\$0</b>	Standard armless	
80A	<b>+\$293</b>	Black "C" shape fixed arms	
90A	<b>+\$404</b>	Fully upholstered "C" shape fixed arms	
96A	<b>+\$225</b>	Black cantilever fixed arms	
97A	<b>+\$307</b>	Polished cantilever fixed arms with black armrest	

## 2a. Arm #90A: + Textile Grade

Part #	Price	Description
GR A	<b>+\$0</b>	Grade A fabric, vinyl or leather
GR B	<b>+\$2</b>	Grade B fabric, vinyl or leather
GR 1	<b>+\$4</b>	Grade 1 fabric, vinyl or leather
COM	<b>+\$4</b>	Customer's Own Fabric or Vinyl
GR 2	<b>+\$9</b>	Grade 2 fabric, vinyl or leather
GR 3	<b>+\$12</b>	Grade 3 fabric, vinyl or leather
COL	<b>+\$12</b>	Customer's Own Leather
GR 4	<b>+\$24</b>	Grade 4 fabric, vinyl or leather
GR 5	<b>+\$29</b>	Grade 5 fabric, vinyl or leather
GR 6	<b>+\$39</b>	Grade 6 fabric, vinyl or leather
GR 7	<b>+\$54</b>	Grade 7 fabric, vinyl or leather
GR 8	<b>+\$68</b>	Grade 8 fabric, vinyl or leather

## 3. Packaging

Part #	Price	Description
9FA	<b>+\$0</b>	Ships 95% assembled
FA	<b>+\$98</b>	Ships fully assembled in the box
BW	<b>CALL US</b>	Ships blanket wrapped w/ minimum order quantity 150 - Call 1-800-433-6614 for pricing

## 4. Textile

Part #	Price	Description
GR A	<b>+\$0</b>	Grade A fabric, vinyl or leather
GR B	<b>+\$37</b>	Grade B fabric, vinyl or leather
GR 1	<b>+\$108</b>	Grade 1 fabric, vinyl or leather
COM	<b>+\$108</b>	Customer's Own Fabric or Vinyl
GR 2	<b>+\$163</b>	Grade 2 fabric, vinyl or leather
GR 3	<b>+\$255</b>	Grade 3 fabric, vinyl or leather
COL	<b>+\$255</b>	Customer's Own Leather
GR 4	<b>+\$368</b>	Grade 4 fabric, vinyl or leather
GR 5	<b>+\$494</b>	Grade 5 fabric, vinyl or leather
GR 6	<b>+\$660</b>	Grade 6 fabric, vinyl or leather
GR 7	<b>+\$858</b>	Grade 7 fabric, vinyl or leather
GR 8	<b>+\$1114</b>	Grade 8 fabric, vinyl or leather

## Build Model String

\_\_ - \_\_ - \_\_ - \_\_ - \_\_  
1 2 2A 3 4

Example:

6901-71C-20JRY-0A-9FA-GR A (ORIGIN JET)



Quoting is easiest with Via's online quote software that renders & prices your model in real time. Scan the QR code or visit <https://viaseating.com/spec-it/#/carmel>

# Carmel

All chair key specification details  
#6901, #6901J & #6903



## Key Details



### Quick Ship / 48-Hour Manufacturing

10 chairs/5 with diamond stitch/2 with upholstered arms made in 48 hours with stocked textiles. See [viaseating.com/](http://viaseating.com/)



### Warranty

12 year warranty.  
See [viaseating.com/warranty/](http://viaseating.com/warranty/)

## Specifications

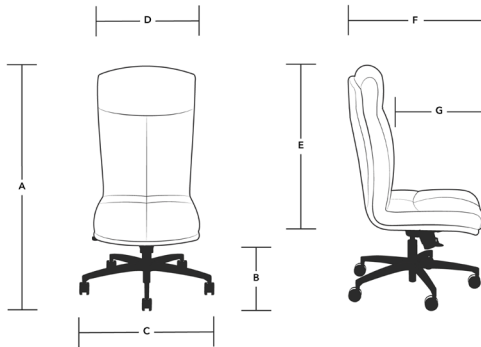

	BACK:		MID BACK				HIGH BACK				JURY CHAIR		
CONTROL:	71C	42C	67C				71C	42C	67C		71C		
SEAT DEPTH:	/	/	/	/	SS	/	/	/	/	SS	/		
FIXED/RATCHET BACK:	/	/	/	RB	/	RB	/	RB	/	RB	/		
<b>Dimensions</b>													
A(-) - Min Height	38.5"	41.5"	40.0"	40.0"	40.0"	40.0"	43.0"	45.5"	44.0"	44.0"	44.0"	44.0"	39.0"
A(+) - Max Height	43.5"	46.0"	44.5"	47.0"	44.5"	47.0"	47.5"	50.5"	49.0"	51.5"	49.0"	51.5"	43.0"
B(-) - Min Seat to Floor	16.5"	20.0"	17.5"	17.5"	18.0"	18.0"	16.5"	20.0"	17.5"	17.5"	18.0"	18.0"	17.0"
B(+) - Max Seat to Floor	21.0"	24.5"	22.0"	22.0"	22.5"	22.5"	21.0"	24.5"	22.0"	22.0"	22.5"	22.5"	20.5"
C - Max Width	26.5"	26.5"	26.5"	26.5"	26.5"	26.5"	26.5"	26.5"	26.5"	26.5"	26.5"	26.5"	/
D - Seat Width	19.5"	19.5"	19.5"	19.5"	19.5"	19.5"	19.5"	19.5"	19.5"	19.5"	19.5"	19.5"	19.5"
E(-) - Min Backrest Height	/	/	/	24.5"	/	24.0"	/	/	/	29.0"	/	28.5"	/
E(+) - Max Backrest Height	25.0"	25.0"	24.5"	27.0"	24.0"	26.5"	29.0"	29.0"	29.0"	31.5"	28.5"	31.0"	25.0"
F(-) - Min Depth	/	/	/	/	27.5"	27.5"	/	/	/	/	27.5"	27.5"	/
F(+) - Max Depth	27.5"	27.5"	27.5"	27.5"	30.0"	30.0"	27.5"	27.5"	27.5"	27.5"	30.0"	30.0"	27.5"
G(-) - Min Seat Depth	/	/	/	/	17.0"	17.0"	/	/	/	/	17.0"	17.0"	/
G(+) - Max Seat Depth	17.5"	17.5"	17.5"	17.5"	19.5"	19.5"	17.0"	17.0"	17.5"	17.5"	19.5"	19.5"	17.5"
<b>Weights</b>													
Weight Capacity	300 lb		350 lb		350 lb		300 lb		350 lb		350 lb		300 lb
Product Weight	40.0 lb	43.0 lb	46.0 lb	46.0 lb	48.0 lb	56.0 lb	40.0 lb	43.0 lb	51.0 lb	51.0 lb	53.0 lb	53.0 lb	37.0 lb



# Carmel

COM/COL & key arm specification details  
#6901, #6901J & #6903



## COM/COL

BACK STYLE:	MID BACK #6901	HIGH BACK #6903
<b>Textiles</b>		
Full chair COM	1.8 yd / 1.81 yd	1.92 yd / 1.91 yd
Full chair COL	28.0 sq ft	30.5 sq ft



**Need Support?** COM/COL amounts are listed for a single product. We are happy to supply yardage requirement quotes for multiple (any more than 1) chair orders, as material cost savings may be realized. Please call 1-800-433-6614 or contact your CAS support at West (CSWest@viaseating.com), South (CSSouth@viaseating.com), North (CSNorth@viaseating.com) or Canada (cscanada@viaseating.com).

## Specifications: Arms

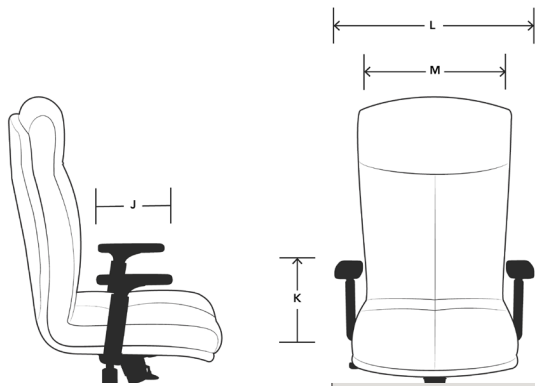

ARM:	51A, 53A		80A	90A	96A	97A
WIDTH BRACKET:	/	19AB	/	/	/	/

Dimensions						
J - Armrest Length	10.0"	10.0"	12.5"	12.5"	12.0"	12.0"
K(-) - Min Armrest Height	8.5"	8.5"	/	/	/	/
K(+) - Max Armrest Height	12.0"	12.0"	9.0"	9.0"	7.0"	7.0"
L(-) - Min Armrest Width	/	26.0"	/	/	/	/
L(+) - Max Armrest Width	26.0"	30.0"	25.0"	25.5"	24.5"	24.5"
M(-) - Min Width Between Armrests	/	20.0"	/	/	/	/
M(+) - Max Width Between Armrests	20.0"	24.0"	19.5"	22.5"	20.5"	20.5"
Weights						
Product Weight	+3.0 lb	+7.0 lb	+8.0 lb	+8.0 lb	+7.0 lb	+7.5 lb
Textiles						
COM	N/A	N/A	N/A	1.25 yd	N/A	N/A
COL	N/A	N/A	N/A	8 sq ft	N/A	N/A

