



**CORTINA.026**

Panca piana / Flat bench

DESIGN Basaglia + Rota Nodari



DESCRIZIONE / DESCRIPTION

Cortina.026 panca piana ha una linea essenziale, archetipa e dal design intramontabile. Grazie alla certificazione self standing e all'innovativo plus di impilaggio è il prodotto ideale per spazi HORECA come bar, ristoranti, gelaterie, ma ideale anche per l'outdoor urbano grazie alla possibilità di fissaggio a terra tramite piastre di ancoraggio. Un progetto innovativo, disponibile standard in tre misure (180, 120 e 60 cm) per facilitare composizioni modulari e dall'ampia gamma colori di serie. Cortina.026 flat bench has an essential, archetypal line with a timeless design. Thanks to the self-standing certification and the innovative stacking plus, it is the ideal product for HORECA spaces such as bars, restaurants, ice cream parlors, but also for traditional urban spaces thanks to the possibility of fixing to the ground using metal plates. An innovative project, available standard in three sizes (180, 120 and 60 cm) for easy modular compositions and with a wide range of standard colors.

DESCRIZIONI TECNICHE / TECHNICAL DESCRIPTIONS

**Struttura / Structure**  
Tubolare in acciaio zincato a caldo e verniciato con polveri poliestere opache raggrinzanti.  
Hot-dip galvanized steel tube with matte polyester powder coat colors.

**Fissaggio / Ground-Fixing**  
Necessita di piastra di ancoraggio. Per l'ancoraggio su superficie rigida si consiglia l'utilizzo di ancoranti M8X90/30 in acciaio inox o zincati.  
Requires metal anchor plates. For anchoring to a hard surface we recommend using M8X90/30 stainless steel or galvanized anchors.

**Montaggio / Assembly**  
Il prodotto viene spedito già montato (#FA).  
Product ships fully assembled (#FA).

LISTINO PREZZI / PRICE LIST

Tipologia / Type	Finitura / Finish	Codice articolo / Item Code	LIST Price \$
Panca piana 60 Flat bench 60 (1 seater) (A)	RAL 1004 - Giallo / Yellow	D200-6-FA	\$922
	RAL 5023 - Azzurro / Light blue	D200-7-FA	\$922
	RAL 3000 - Rosso / Red	D200-4-FA	\$922
	RAL 7032 - Sabbia / Sand	D200-9-FA	\$922
	RAL 7024 - Antracite micaceo / Micaceous anthracite	D200-2-FA	\$922
	RAL 9005 - Nero / Black	D200-1-FA	\$922
Panca piana 120 Flat bench 120 (2 seater) (B)	RAL 9003 - Bianco / White	D200-3-FA	\$922
	RAL 1004 - Giallo / Yellow	D205-6-FA	\$1364
	RAL 5023 - Azzurro / Light blue	D205-7-FA	\$1364
	RAL 3000 - Rosso / Red	D205-4-FA	\$1364
	RAL 7032 - Sabbia / Sand	D205-5-FA	\$1364
	RAL 7024 - Antracite micaceo / Micaceous anthracite	D205-2-FA	\$1364
Panca piana 180 Flat bench 180 (3 seater) (C)	RAL 9005 - Nero / Black	D205-1-FA	\$1364
	RAL 9003 - Bianco / White	D205-3-FA	\$1364
	RAL 1004 - Giallo / Yellow	D210-6-FA	\$2050
	RAL 5023 - Azzurro / Light blue	D210-7-FA	\$2050
	RAL 3000 - Rosso / Red	D210-4-FA	\$2050
	RAL 7032 - Sabbia / Sand	D210-5-FA	\$2050
Panca piana 180 Flat bench 180 (3 seater) (C)	RAL 7024 - Antracite micaceo / Micaceous anthracite	D210-2-FA	\$2050
	RAL 9005 - Nero / Black	D210-1-FA	\$2050
	RAL 9003 - Bianco / White	D210-3-FA	\$2050

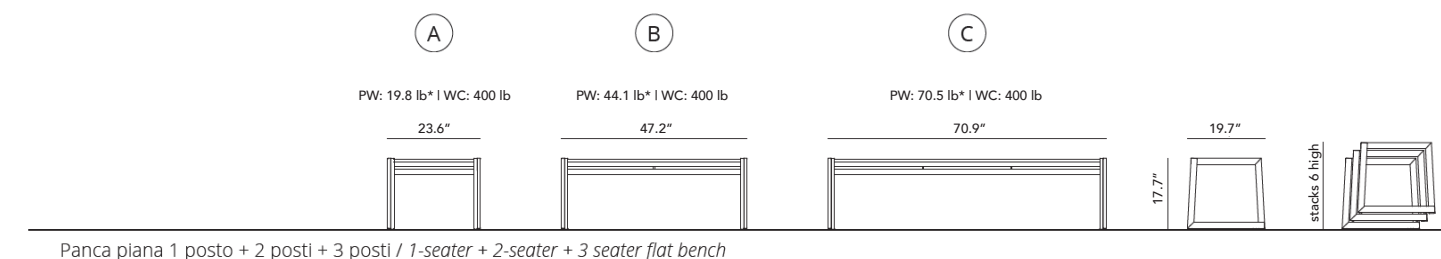

\* Imballo escluso / packaging excluded

**CORTINA.026**

Panca con schienale / *Bench with backrest*

**DESIGN** Basaglia + Rota Nodari



**DESCRIZIONE / DESCRIPTION**

La panca con schienale Cortina.026 ha una linea essenziale, archetipa e dal design intramontabile. Grazie alla certificazione self standing e all'innovativo plus di impilaggio è il prodotto ideale per spazi HORECA come bar, ristoranti, gelaterie, ma ideale anche per l'outdoor urbano grazie alla possibilità di fissaggio a terra tramite piastre di ancoraggio. Un progetto innovativo, disponibile standard in tre misure (180, 120 e 60 cm) per facilitare composizioni modulari e dall'ampia gamma colori di serie.

*The bench with backrest Cortina.026 has an essential, archetypal line with a timeless design. Thanks to the self-standing certification and the innovative stacking plus, it is the ideal product for HORECA spaces such as bars, restaurants, ice cream parlors, but also for traditional urban spaces thanks to the possibility of fixing to the ground using metal plates. An innovative project, available standard in three sizes (180, 120 and 60 cm) for easy modular compositions and with a wide range of standard colors.*

**DESCRIZIONI TECNICHE / TECHNICAL DESCRIPTIONS**

**Struttura / Structure**  
Tubolare in acciaio zincato a caldo e verniciato con polveri poliestere opache raggrinzanti.  
*Hot-dip galvanized steel tube with matte polyester powder coat colors.*

**Fissaggio / Ground-Fixing**  
Necessita di piastra di ancoraggio. Per l'ancoraggio su superficie rigida si consiglia l'utilizzo di ancoranti M8X90/30 in acciaio inox o zincati.  
*Requires metal anchor plates. For anchoring to a hard surface we recommend using M8X90/30 stainless steel or galvanized anchors.*

**Montaggio / Assembly**  
Il prodotto viene spedito già montato (#FA).  
*Product ships fully assembled (#FA).*

**LISTINO PREZZI / PRICE LIST**

Tipologia / Type	Finitura / Finish	Codice articolo / Item Code	LIST Price \$
● Panca con schienale 60 Bench with backrest 60 (1 seater) Ⓐ	RAL 1004 - Giallo / Yellow	D215-6-FA	\$1242
	RAL 5023 - Azzurro / Light blue	D215-7-FA	\$1242
	RAL 3000 - Rosso / Red	D215-4-FA	\$1242
	RAL 7032 - Sabbia / Sand	D215-9-FA	\$1242
	RAL 7024 - Antracite micaceo / Micaceous anthracite	D215-2-FA	\$1242
	RAL 9005 - Nero / Black	D215-1-FA	\$1242
● Panca con schienale 120 Bench with backrest 120 (2 seater) Ⓑ	RAL 1004 - Giallo / Yellow	D220-6-FA	\$1975
	RAL 5023 - Azzurro / Light blue	D220-7-FA	\$1975
	RAL 3000 - Rosso / Red	D220-4-FA	\$1975
	RAL 7032 - Sabbia / Sand	D220-5-FA	\$1975
	RAL 7024 - Antracite micaceo / Micaceous anthracite	D220-2-FA	\$1975
	RAL 9005 - Nero / Black	D220-1-FA	\$1975
● Panca con schienale 180 Bench with backrest 180 (3 seater) Ⓒ	RAL 1004 - Giallo / Yellow	D225-6-FA	\$2463
	RAL 5023 - Azzurro / Light blue	D225-7-FA	\$2463
	RAL 3000 - Rosso / Red	D225-4-FA	\$2463
	RAL 7032 - Sabbia / Sand	D225-5-FA	\$2463
	RAL 7024 - Antracite micaceo / Micaceous anthracite	D225-2-FA	\$2463
	RAL 9005 - Nero / Black	D225-1-FA	\$2463
	RAL 9003 - Bianco / White	D225-3-FA	\$2463

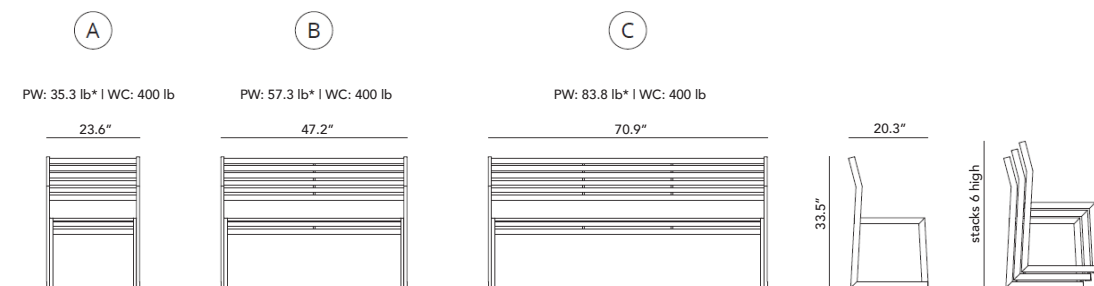

Panca con schienale 1 posto + 2 posti + 3 posti / 1-seater + 2-seater + 3 seater bench with backrest

\* Imballo escluso / *packaging excluded*

**CORTINA.026**

Tavolo / Table

**DESIGN** Basaglia + Rota Nodari



**DESCRIZIONE / DESCRIPTION**

Il concept essenziale di questo tavolo impilabile viene esaltato dalla struttura leggera ma affidabile, in un binomio di classico e moderno frutto di un'attenta progettazione di linee e di fruibilità. Un prodotto versatile e in grado di adattarsi elegantemente ad ogni esigenza, da banco scolastico a tavolo urbano.  
*The essential concept of this stackable table is enhanced by the light but reliable structure, in a combination of classic and modern, the result of a careful design of lines and usability. A versatile product able to elegantly adapt to every need, from school desk to urban table.*

**DESCRIZIONI TECNICHE / TECHNICAL DESCRIPTIONS**

**Struttura / Structure**  
 Tubolare in acciaio zincato a caldo e verniciato con polveri poliestere opache raggrinzanti. Top in alluminio verniciato con polveri poliestere raggrinzanti.  
*Hot-dip galvanized steel tube with matte polyester powder coat colors. Aluminum top with matte polyester powder coat colors.*

**Fissaggio / Ground-Fixing**  
 Necessita di piastra di ancoraggio. Per l'ancoraggio su superficie rigida si consiglia l'utilizzo di ancoranti M8X90/30 in acciaio inox o zincati.  
*Requires metal anchor plates. For anchoring to a hard surface we recommend using M8X90/30 stainless steel or galvanized anchors.*

**Montaggio / Assembly**  
 Il prodotto viene spedito già montato (#FA).  
*Product ships fully assembled (#FA).*

**LISTINO PREZZI / PRICE LIST**

Tipologia / Type	Finitura / Finish	Codice articolo / Item Code	LIST Price \$
60 x 60cm Tavolo monoposto 20.6" x 20.6" Single-seater table	RAL 1004 - Giallo / Yellow	D231-6-FA	\$1242
	RAL 5023 - Azzurro / Light blue	D231-7-FA	\$1242
	RAL 3000 - Rosso / Red	D231-4-FA	\$1242
	RAL 7032 - Sabbia / Sand	D231-9-FA	\$1242
	RAL 7024 - Antracite micaceo / Micaceous anthracite	D231-2-FA	\$1242
	RAL 9005 - Nero / Black	D231-1-FA	\$1242
60 x 72,4cm Tavolo 20.6" x 28.5" Table	RAL 9003 - Bianco / White	D231-3-FA	\$1242
	RAL 1004 - Giallo / Yellow	D230-6-FA	\$1090
	RAL 5023 - Azzurro / Light blue	D230-7-FA	\$1090
	RAL 3000 - Rosso / Red	D230-4-FA	\$1090
	RAL 7032 - Sabbia / Sand	D230-5-FA	\$1090
	RAL 7024 - Antracite micaceo / Micaceous anthracite	D230-2-FA	\$1090
120 x 72,4cm Tavolo 47.2" x 28.5" Table	RAL 9005 - Nero / Black	D230-1-FA	\$1090
	RAL 9003 - Bianco / White	D230-3-FA	\$1090
	RAL 1004 - Giallo / Yellow	D235-6-FA	\$1502
	RAL 5023 - Azzurro / Light blue	D235-7-FA	\$1502
	RAL 3000 - Rosso / Red	D235-4-FA	\$1502
	RAL 7032 - Sabbia / Sand	D235-5-FA	\$1502
C	RAL 7024 - Antracite micaceo / Micaceous anthracite	D235-2-FA	\$1502
	RAL 9005 - Nero / Black	D235-1-FA	\$1502
	RAL 9003 - Bianco / White	D235-3-FA	\$1502

Tipologia / Type	Finitura / Finish	Codice articolo / Item Code	LIST Price \$
180 x 72,4 cm Tavolo 70.9" x 28.5" Table	RAL 1004 - Giallo / Yellow	D240-6-FA	\$1925
	RAL 5023 - Azzurro / Light blue	D240-7-FA	\$1925
	RAL 3000 - Rosso / Red	D240-4-FA	\$1925
	RAL 7032 - Sabbia / Sand	D240-9-FA	\$1925
	RAL 7024 - Antracite micaceo / Micaceous anthracite	D240-2-FA	\$1925
	RAL 9005 - Nero / Black	D240-1-FA	\$1925
	RAL 9003 - Bianco / White	D240-3-FA	\$1925

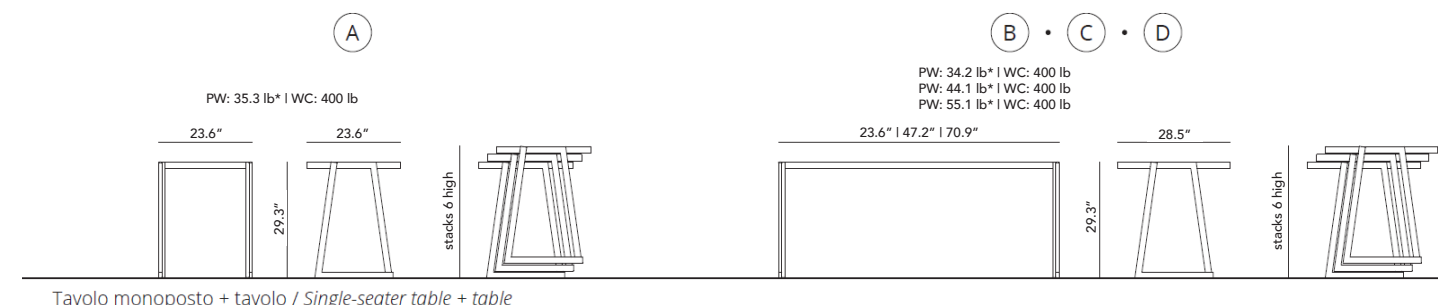

















\* Imballo escluso / packaging excluded

**CORTINA.026**

Accessori . Panche + tavolo / **Accessories . Benches + table**

**DESIGN** Basaglia + Rota Nodari

LISTINO PREZZI / **PRICE LIST**

Tipologia / Type	Finitura / Finish	Codice articolo / Item Code	LIST Price \$
      Coppia di piastre di ancoraggio a terra Pair of brackets for ground fixing	RAL 1004 - Giallo / Yellow	DC10-6-FA	\$295
	RAL 5023 - Azzurro / Light blue	DC10-7-FA	\$295
	RAL 3000 - Rosso / Red	DC10-4-FA	\$295
	RAL 7032 - Sabbia / Sand	DC10-9-FA	\$295
	RAL 7024 - Antracite micaceo / Micaceous anthracite	DC10-2-FA	\$295
	  (A)	RAL 9005 - Nero / Black	DC10-1-FA
RAL 9003 - Bianco / White	DC10-3-FA	\$295	
      Pair of brackets for ground fixing - ADA	RAL 1004 - Giallo / Yellow	DC20-6-FA	\$466
	RAL 5023 - Azzurro / Light blue	DC20-7-FA	\$466
	RAL 3000 - Rosso / Red	DC20-4-FA	\$466
	RAL 7032 - Sabbia / Sand	DC20-5-FA	\$466
	RAL 7024 - Antracite micaceo / Micaceous anthracite	DC20-2-FA	\$466
	  (B)	RAL 9005 - Nero / Black	DC20-1-FA
RAL 9003 - Bianco / White	DC20-3-FA	\$466	

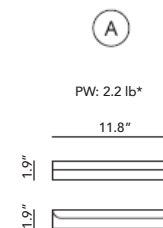
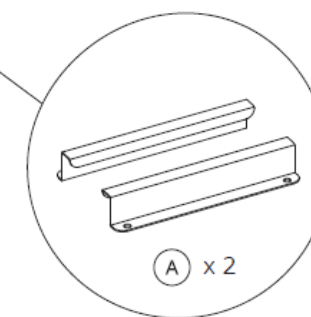
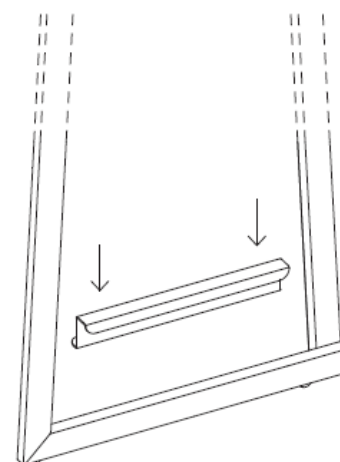

Piastre / Brackets

\* Imballo escluso / packaging excluded

**CORTINA.026**

Cestoni / Big litter bins

**DESIGN** Basaglia + Rota Nodari

**DESCRIZIONE / DESCRIPTION**

La funzionalità si veste di nuovi colori. Cestone dal design deciso e distintivo accompagna l'intera collezione senza incertezze. Nella versione con coperchio disponibili accessori posacenere e targhette per la raccolta differenziata. Versione light per esigenze di leggerezza. Struttura in tubi metallici trattati con zincatura a caldo e verniciata in polveri poliestere. Predisposto per fissaggio a terra con tasselli.

Functionality takes on new colors. Basket with a strong and distinctive design who accompanies the entire collection without hesitation. The high lid version could be mounted with accessories like ashtray and plates for separate waste collection. Light version available for lightness needs.

**DESCRIZIONI TECNICHE / TECHNICAL DESCRIPTIONS**

**Struttura / Structure**

Tubolare in acciaio zincato a caldo e verniciato con polveri poliestere opache raggrinzanti. Coperchio e contenitore interno in acciaio zincato e verniciato con polveri poliestere opache raggrinzanti.

Hot-dip galvanized steel tube with matte polyester powder coat colors. Cover and interbal bin in galvanized steel with matte polyester powder coat colors.

**Fissaggio / Ground-Fixing**

Predisposto per il fissaggio a terra con tasselli o per l'aggancio multiplo con piastra d'acciaio. Per l'ancoraggio su superficie rigida si consiglia l'utilizzo di ancoranti M8X90/30 in acciaio inox o zincati.

Ready-equipped for fastening to the ground with bolts or connection with metal plates. For anchoring to a hard surface we recommend using M8X90/30 stainless steel or galvanized anchors.

**Montaggio / Assembly**

Il prodotto viene spedito già montato (#FA).

Product ships fully assembled (#FA).

**LISTINO PREZZI / PRICE LIST**

Tipologia / Type	Finitura / Finish	Codice articolo / Item Code	LIST Price \$
Cestone Big litter bin	RAL 1004 - Giallo / Yellow	D245-6-FA	\$2638
	RAL 5023 - Azzurro / Light blue	D245-7-FA	\$2638
	RAL 3000 - Rosso / Red	D245-4-FA	\$2638
	RAL 7032 - Sabbia / Sand	D245-9-FA	\$2638
	RAL 7024 - Antracite micaceo / Micaceous anthracite	D245-2-FA	\$2638
	RAL 9005 - Nero / Black	D245-1-FA	\$2638
Cestone accessoriabile Customizable big litter bin	RAL 1004 - Giallo / Yellow	D250-6-FA	\$2820
	RAL 5023 - Azzurro / Light blue	D250-7-FA	\$2820
	RAL 3000 - Rosso / Red	D250-4-FA	\$2820
	RAL 7032 - Sabbia / Sand	D250-5-FA	\$2820
	RAL 7024 - Antracite micaceo / Micaceous anthracite	D250-2-FA	\$2820
	RAL 9005 - Nero / Black	D250-1-FA	\$2820
	RAL 9003 - Bianco / White	D250-3-FA	\$2820



Tipologia / Type	Grafica / Graphics	Finitura / Finish	Codice articolo / Item Code	LIST Price \$	
●		"Plastic" label	Acciaio inox / Stainless steel	DL01	\$0
●		"Waste" label	Acciaio inox / Stainless steel	DL02	\$0
● Etichetta differenziata Recycling label		"Aluminum" label	Acciaio inox / Stainless steel	DL03	\$0
●		"Paper" label	Acciaio inox / Stainless steel	DL04	\$0
●		"Organic Matter" label	Acciaio inox / Stainless steel	DL05	\$0
●		"Plastic" label	Acciaio inox / Stainless steel	DLA1	\$135
●		"Waste" label	Acciaio inox / Stainless steel	DLA2	\$135
● Etichetta differenziata + etichetta posacenere Recycling label + ashtray label <sup>1</sup>		"Aluminum" label	Acciaio inox / Stainless steel	DLA3	\$135
●		"Paper" label	Acciaio inox / Stainless steel	DLA4	\$135
●		"Organic Matter" label	Acciaio inox / Stainless steel	DLA5	\$135

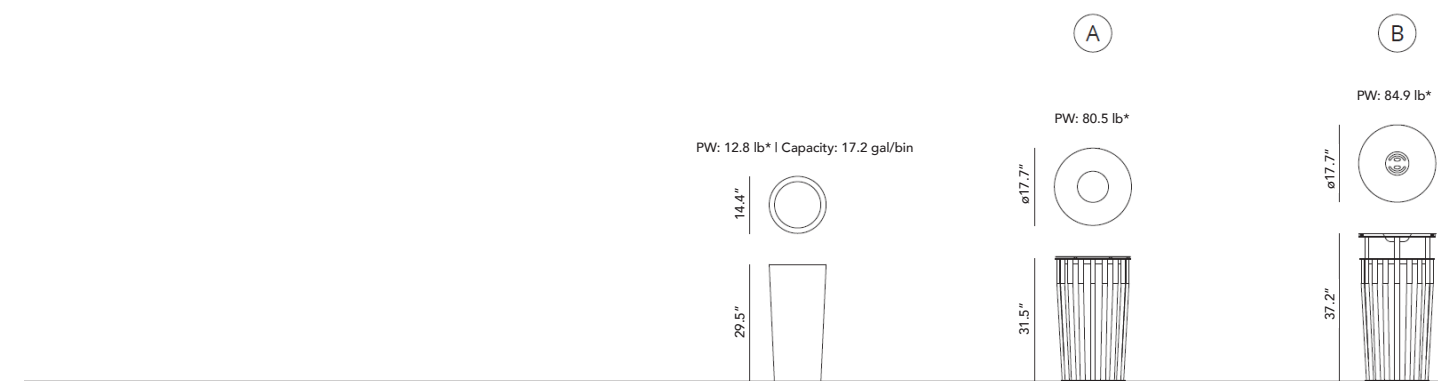

Contenitore interno + cestone + cestone accessoriabile / Inner container + big litter bin + customizable big litter bin

\* Imballo escluso / packaging excluded