



SIERRA.015

Cubes

DESIGN Basaglia & Rota Nodari





The Sierra.015 collection cubes by Italian designers Basaglia & Rota Nodari offer a large & small backless seat as well as a table version. The signature bent 18mm diameter pipes that shape their form, disperse heat in the summer without freezing over in the winter thanks to their hot-dip galvanized steel & hollow interior. Offered in satin stainless steel or polyester power-coating in a variety of colors. Ready-equipped for fastening to the ground with bolts or joined together using steel plates.

Structure: Hot-dip galvanized steel with matte polyester powder coat colors or a satin finish on select models

Manufactured in Italy / Assembly: Product ships fully assembled / Ground Fixing: Bracket connected or ground-bolted

Freight: Not included in LIST Price - See freight table / GSA: Open Market

BASE MODEL	PART #	FINISH	LIST PRICE \$
Cube chair 	● XCUBE-1	Black - Pantone Black, RAL 9005	\$1502
	● XCUBE-2	Anthracite - Speckled texture, RAL 7024	\$1502
	○ XCUBE-3	White - Pantone 705, RAL 9003	\$1502
	● XCUBE-18	Corten - Speckled texture	\$1502
	● XCUBE-5	Green - Pantone 349, RAL 6029	\$1502
	● XCUBE-4	Red - Pantone 187, RAL 3000	\$1502
	● XCUBE-11	Satin-finish on stainless steel	\$2883
	Max Weight: 2500 lb		
Small cube chair 	● XLCUBE-1	Black - Pantone Black, RAL 9005	\$937
	● XLCUBE-2	Anthracite - Speckled texture, RAL 7024	\$937
	○ XLCUBE-3	White - Pantone 705, RAL 9003	\$937
	● XLCUBE-7	Light Blue - Pantone 5405, RAL 5023	\$937
	● XLCUBE-5	Green - Pantone 349, RAL 6029	\$937
	● XLCUBE-4	Red - Pantone 187, RAL 3000	\$937
	● XLCUBE-6	Yellow - Pantone 124, RAL 1004	\$937
	Max Weight: 2500 lb		
Cube table 	● XCUBET-1	Black - Pantone Black, RAL 9005	\$1801
	● XCUBET-2	Anthracite - Speckled texture, RAL 7024	\$1801
	○ XCUBET-3	White - Pantone 705, RAL 9003	\$1801
	● XCUBET-18	Corten - Speckled texture	\$1801
	● XCUBET-5	Green - Pantone 349, RAL 6029	\$1801
	● XCUBET-4	Red - Pantone 187, RAL 3000	\$1801
	● XCUBET-11	Satin-finish on stainless steel	\$3455
	Max Weight: 2500 lb		

Additional Options

Chairs Only: Optional Skate Guards

OPTION	PART #	DESCRIPTION	LIST PRICE \$
Skate guard	-UT15	Skate guards to prevent people from grinding their skateboard on the furniture. Sold as a pack of 2 guards.	\$157



Product Assembly

OPTION	PART #	DESCRIPTION	LIST PRICE \$
Fully Assembled	-FA	Models arrive fully assembled.	\$0

Dimensions

The below dimensions were recorded by the URBANTIME® team using centimeters (cm) for distances & kilograms (kg) for product weight as the unit of measurement. Note, packaging not included.

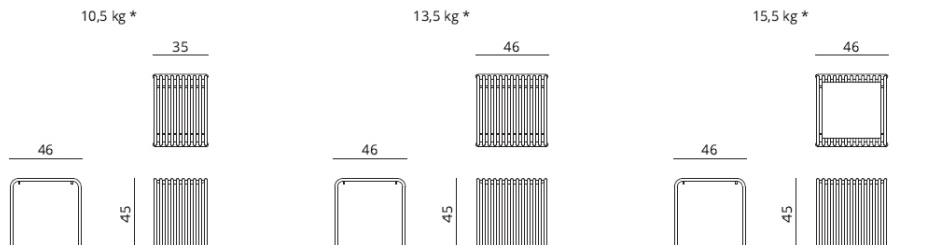

Small cube chair / Cube chair / Cube table

SIERRA.015



School Stools + Tables

DESIGN Basaglia & Rota Nodari



The Sierra.015 collection school tables & stools by Italian designers Basaglia & Rota Nodari offer adaptability to all environments without losing the shape of an unmistakable collection. Configure a two-seater workstation, hook up the bag or fix the furniture to the floor, everything is possible with 015 school. The aluminum top also allows easy movement of the seat and table. Ready-equipped for fastening to the ground with bolts. Stacks 3 high.

Structure: Hot-dip galvanized steel framework & aluminum top with matte polyester powder coat colors
 Manufactured in Italy / Assembly: Product ships fully assembled / Ground Fixing: Bracket connected or ground-bolted
Freight: Not included in LIST Price - See freight table / GSA: Open Market

BASE MODEL	PART #	FINISH	LIST PRICE \$
School stool 	● XOLS-1	Black - Pantone Black, RAL 9005	\$1591
	● XOLS-2	Anthracite - Speckled texture, RAL 7024	\$1591
	○ XOLS-3	White - Pantone 705, RAL 9003	\$1591
	● XOLS-7	Light Blue - Pantone 5405, RAL 5023	\$1591
	● XOLS-5	Green - Pantone 349, RAL 6029	\$1591
	● XOLS-4	Red - Pantone 187, RAL 3000	\$1591
Max Weight: lb	● XOLS-6	Yellow - Pantone 124, RAL 1004	\$1591
School chair 	● XOLT-1	Black - Pantone Black, RAL 9005	\$1911
	● XOLT-2	Anthracite - Speckled texture, RAL 7024	\$1911
	○ XOLT-3	White - Pantone 705, RAL 9003	\$1911
	● XOLT-7	Light Blue - Pantone 5405, RAL 5023	\$1911
	● XOLT-5	Green - Pantone 349, RAL 6029	\$1911
	● XOLT-4	Red - Pantone 187, RAL 3000	\$1911
Max Weight: lb	● XOLT-6	Yellow - Pantone 124, RAL 1004	\$1911

Additional Options

N/A

Product Assembly

<i>OPTION</i>	<i>PART #</i>	<i>DESCRIPTION</i>	<i>LIST PRICE \$</i>
Fully Assembled	-FA	Models arrive fully assembled.	\$0

Dimensions

The below dimensions were recorded by the URBANTIME® team using centimeters (cm) for distances & kilograms (kg) for product weight as the unit of measurement. Note, packaging not included.

Stool / table

SIERRA.015





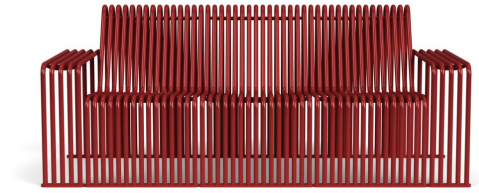













Modular chairs + couches

DESIGN Basaglia & Rota Nodari



The Sierra.015 collection modular seating system by Italian designers Basaglia & Rota Nodari offers easy to order typicals: club chair & 3-seater couch. The signature bent 18mm diameter pipes that shape their form, disperse heat in the summer without freezing over in the winter thanks to their hot-dip galvanized steel & hollow interior. Offered in polyester power-coating in a variety of colors. Ready-equipped for fastening to the ground.

Structure: Hot-dip galvanized steel with matte polyester powder coat colors or a satin finish on select models
 Manufactured in Italy / Assembly: Product ships fully assembled / Ground Fixing: Bracket connected or ground-bolted
Freight: Not included in LIST Price - See freight table / GSA: Open Market

BASE MODEL	PART #	FINISH	LIST PRICE \$
Club chair 	 XCLUB-1	Black - Pantone Black, RAL 9005	\$5017
	 XCLUB-2	Anthracite - Speckled texture, RAL 7024	\$5017
	 XCLUB-3	White - Pantone 705, RAL 9003	\$5017
	 XCLUB-18	Corten - Speckled texture	\$5017
	 XCLUB-7	Light Blue - Pantone 5405, RAL 5023	\$5017
	 XCLUB-5	Green - Pantone 349, RAL 6029	\$5017
	 XCLUB-4	Red - Pantone 187, RAL 3000	\$5017
Max Weight: 2500 lb	 XCLUB-6	Yellow - Pantone 124, RAL 1004	\$5017
Couch 	 XCOUCH-1	Black - Pantone Black, RAL 9005	\$12079
	 XCOUCH-2	Anthracite - Speckled texture, RAL 7024	\$12079
	 XCOUCH-3	White - Pantone 705, RAL 9003	\$12079
	 XCOUCH-18	Corten - Speckled texture	\$12079
	 XCOUCH-7	Light Blue - Pantone 5405, RAL 5023	\$12079
	 XCOUCH-5	Green - Pantone 349, RAL 6029	\$12079
	 XCOUCH-4	Red - Pantone 187, RAL 3000	\$12079
Max Weight: 2500 lb	 XCOUCH-6	Yellow - Pantone 124, RAL 1004	\$12079

<i>BASE MODEL</i>	<i>PART #</i>	<i>FINISH</i>	<i>LIST PRICE \$</i>	
Modular seat 	● XSM-1	Black - Pantone Black, RAL 9005	\$2177	
	● XSM-2	Anthracite - Speckled texture, RAL 7024	\$2177	
	○ XSM-3	White - Pantone 705, RAL 9003	\$2177	
	● XSM-18	Corten - Speckled texture	\$2177	
	● XSM-7	Light Blue - Pantone 5405, RAL 5023	\$2177	
	● XSM-5	Green - Pantone 349, RAL 6029	\$2177	
	● XSM-4	Red - Pantone 187, RAL 3000	\$2177	
	● XSM-6	Yellow - Pantone 124, RAL 1004	\$2177	
	Max Weight: 2500 lb			
	Modular arm 	● XSA-1	Black - Pantone Black, RAL 9005	\$1244
● XSA-2		Anthracite - Speckled texture, RAL 7024	\$1244	
○ XSA-3		White - Pantone 705, RAL 9003	\$1244	
● XSA-18		Corten - Speckled texture	\$1244	
● XSA-7		Light Blue - Pantone 5405, RAL 5023	\$1244	
● XSA-5		Green - Pantone 349, RAL 6029	\$1244	
● XSA-4		Red - Pantone 187, RAL 3000	\$1244	
● XSA-6		Yellow - Pantone 124, RAL 1004	\$1244	
Max Weight: 2500 lb				
Small general fixing bracket 		● XB1-1	Black - Pantone Black, RAL 9005	\$182
	● XB1-2	Anthracite - Speckled texture, RAL 7024	\$182	
	○ XB1-3	White - Pantone 705, RAL 9003	\$182	
	● XB1-18	Corten - Speckled texture	\$182	
	● XB1-7	Light Blue - Pantone 5405, RAL 5023	\$182	
	● XB1-5	Green - Pantone 349, RAL 6029	\$182	
	● XB1-4	Red - Pantone 187, RAL 3000	\$182	
	● XB1-6	Yellow - Pantone 124, RAL 1004	\$182	
	Note: Set of 2			
	Large bracket for connecting middle arms 	● XB2-1	Black - Pantone Black, RAL 9005	\$228
● XB2-2		Anthracite - Speckled texture, RAL 7024	\$228	
○ XB2-3		White - Pantone 705, RAL 9003	\$228	
● XB2-18		Corten - Speckled texture	\$228	
● XB2-7		Light Blue - Pantone 5405, RAL 5023	\$228	
● XB2-5		Green - Pantone 349, RAL 6029	\$228	
● XB2-4		Red - Pantone 187, RAL 3000	\$228	
● XB2-6		Yellow - Pantone 124, RAL 1004	\$228	
Note: Set of 2				

Example Modular Seating Builds

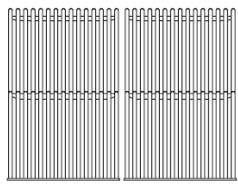

108

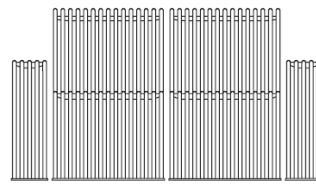

144

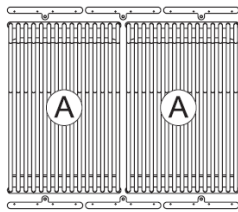

C x 3

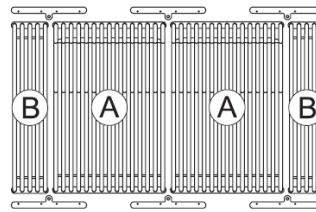

C x 3

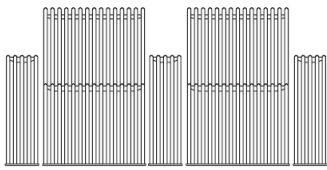

162

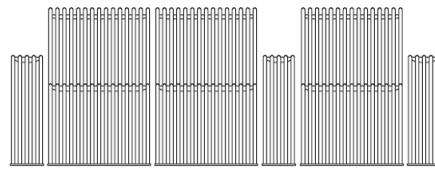

216

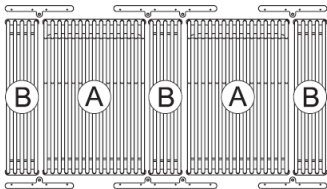

C x 2
D x 1

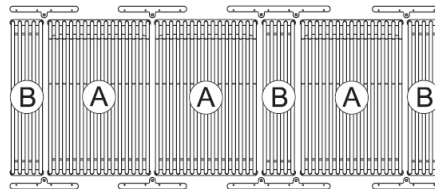

C x 3
D x 1

LEGEND

- A. Modular Seat #XSM
- B. Modular Arm #XSA
- C. Small general fixing bracket #XB1
- D. Large bracket for connecting middle arms #XB2

Additional Options

Chairs Only: Optional Skate Guards

OPTION	PART #	DESCRIPTION	LIST PRICE \$
Skate guard	-UT15	Skate guards to prevent people from grinding their skateboard on the furniture. Sold as a pack of 2 guards.	\$157



Product Assembly

OPTION	PART #	DESCRIPTION	LIST PRICE \$
Fully Assembled	-FA	Models arrive fully assembled.	\$0

Dimensions

The below dimensions were recorded by the URBANTIME® team using centimeters (cm) for distances & kilograms (kg) for product weight as the unit of measurement. Note, packaging not included.

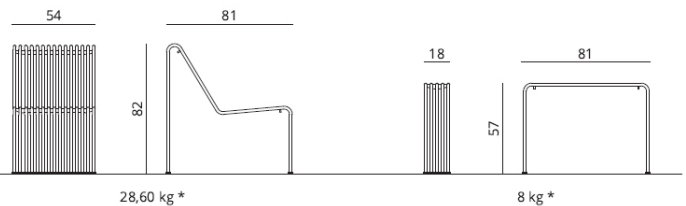

Modular seat & modular arm

SIERRA.015



Flat benches

DESIGN Basaglia & Rota Nodari



The Sierra.015 collection flat benches by Italian designers Basaglia & Rota Nodari are available in straight & curved forms. The signature bent 18mm diameter pipes that shape their form, disperse heat in the summer without freezing over in the winter thanks to their hot-dip galvanized steel & hollow interior. Offered in satin stainless steel or polyester power-coating in a variety of colors. Ready-equipped for fastening to the ground with bolts or joined together using steel plates.

Structure: Hot-dip galvanized steel with matte polyester powder coat colors or a satin finish on select models
 Manufactured in Italy / Assembly: Product ships fully assembled / Ground Fixing: Bracket connected or ground-bolted
Freight: Not included in LIST Price - See freight table / GSA: Open Market

BASE MODEL	PART #	FINISH	LIST PRICE \$
Flat backless bench 	● XFS20-1	Black - Pantone Black, RAL 9005	\$3112
	● XFS20-2	Anthracite - Speckled texture, RAL 7024	\$3112
	○ XFS20-3	White - Pantone 705, RAL 9003	\$3112
	● XFS20-18	Corten - Speckled texture	\$3112
	● XFS20-5	Green - Pantone 349, RAL 6029	\$3112
	● XFS20-4	Red - Pantone 187, RAL 3000	\$3112
	● XFS20-11	Satin-finish on stainless steel	\$4332
Max Weight: 2500 lb			
Curved backless bench 	● XFC15-1	Black - Pantone Black, RAL 9005	\$3630
	● XFC15-2	Anthracite - Speckled texture, RAL 7024	\$3630
	○ XFC15-3	White - Pantone 705, RAL 9003	\$3630
	● XFC15-18	Corten - Speckled texture	\$3630
	● XFC15-5	Green - Pantone 349, RAL 6029	\$3630
	● XFC15-4	Red - Pantone 187, RAL 3000	\$3630
	● XFC15-11	Satin-finish on stainless steel	\$6424
Max Weight: 2500 lb			

Additional Options

Optional Arms

OPTION	PART #	DESCRIPTION	LIST PRICE \$
Fixed arm	-XAF	Arm for the left side, right side or middle location on the flat bench.	\$185

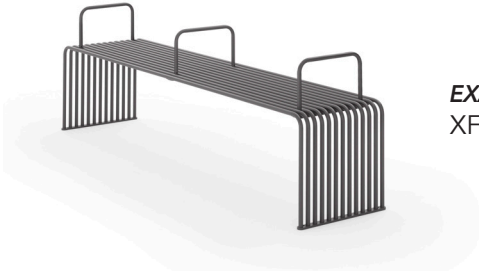

EXAMPLE:
XFS20-2-XAF-2-XAF-2-XAF-2

Optional Backrests

OPTION	PART #	DESCRIPTION	LIST PRICE \$
Fixed backrest	-XHB	Backrest addition with a max of 2 per bench allowed. Can be placed on the left and/or right of the chair.	\$1532



EXAMPLE:
XFS20-2-XHB-2



EXAMPLE:
XFS20-2-XHB-2-XHB-2



EXAMPLE:
XFS20-2-XAF-2-XAF-2-XAF-2-XHB-2-XHB-2

Optional Skate Guards

OPTION	PART #	DESCRIPTION	LIST PRICE \$
Skate guard	-UT15	Skate guards to prevent people from grinding their skateboard on the furniture. Sold as a pack of 2 guards.	\$157



Product Assembly

OPTION	PART #	DESCRIPTION	LIST PRICE \$
Fully Assembled	-FA	Models arrive fully assembled.	\$0

Dimensions

The below dimensions were recorded by the URBANTIME® team using centimeters (cm) for distances & kilograms (kg) for product weight as the unit of measurement. Note, packaging not included.

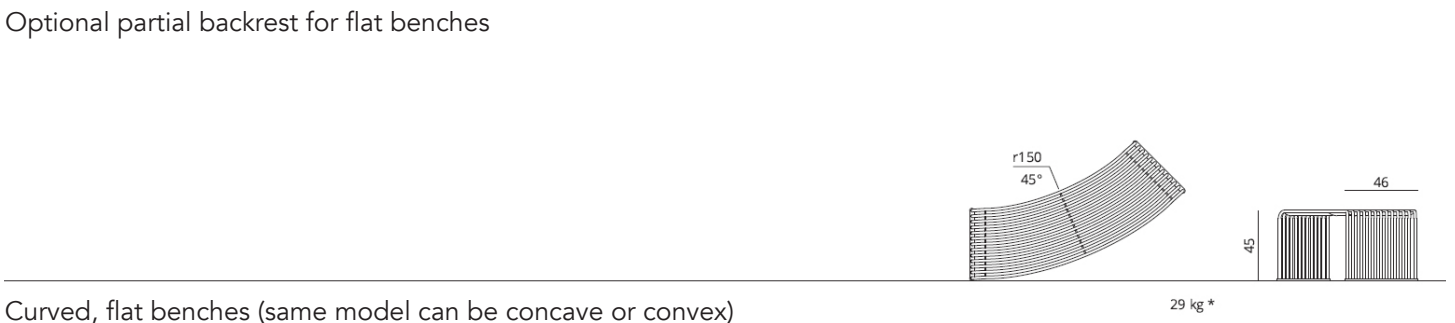
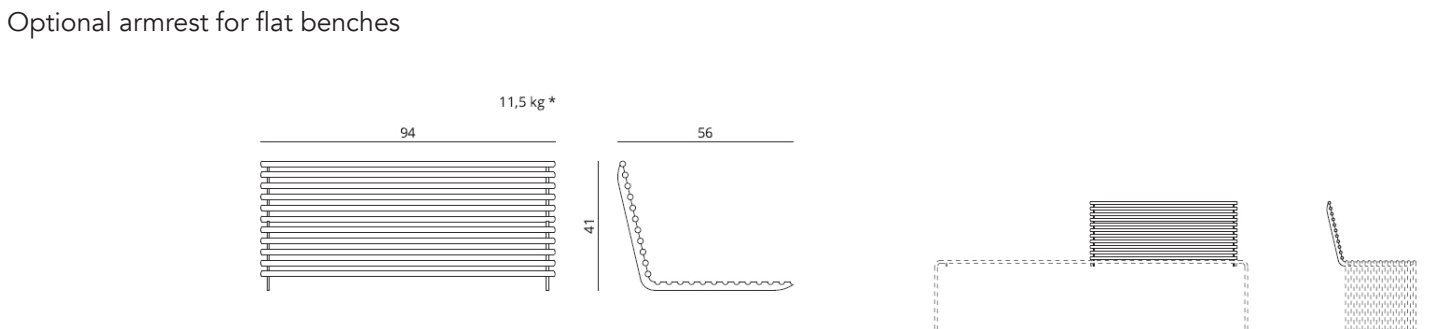
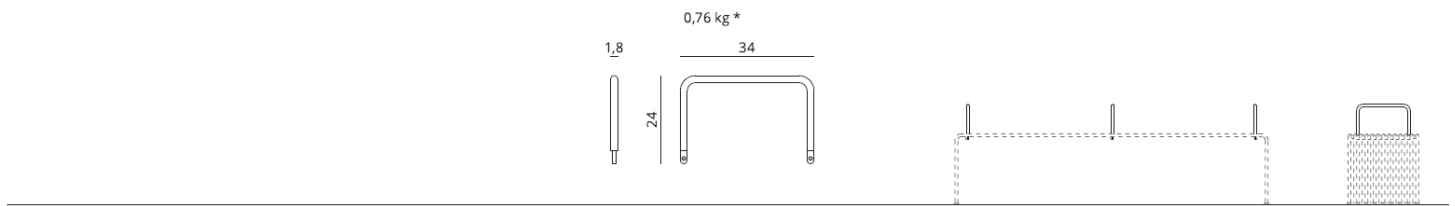

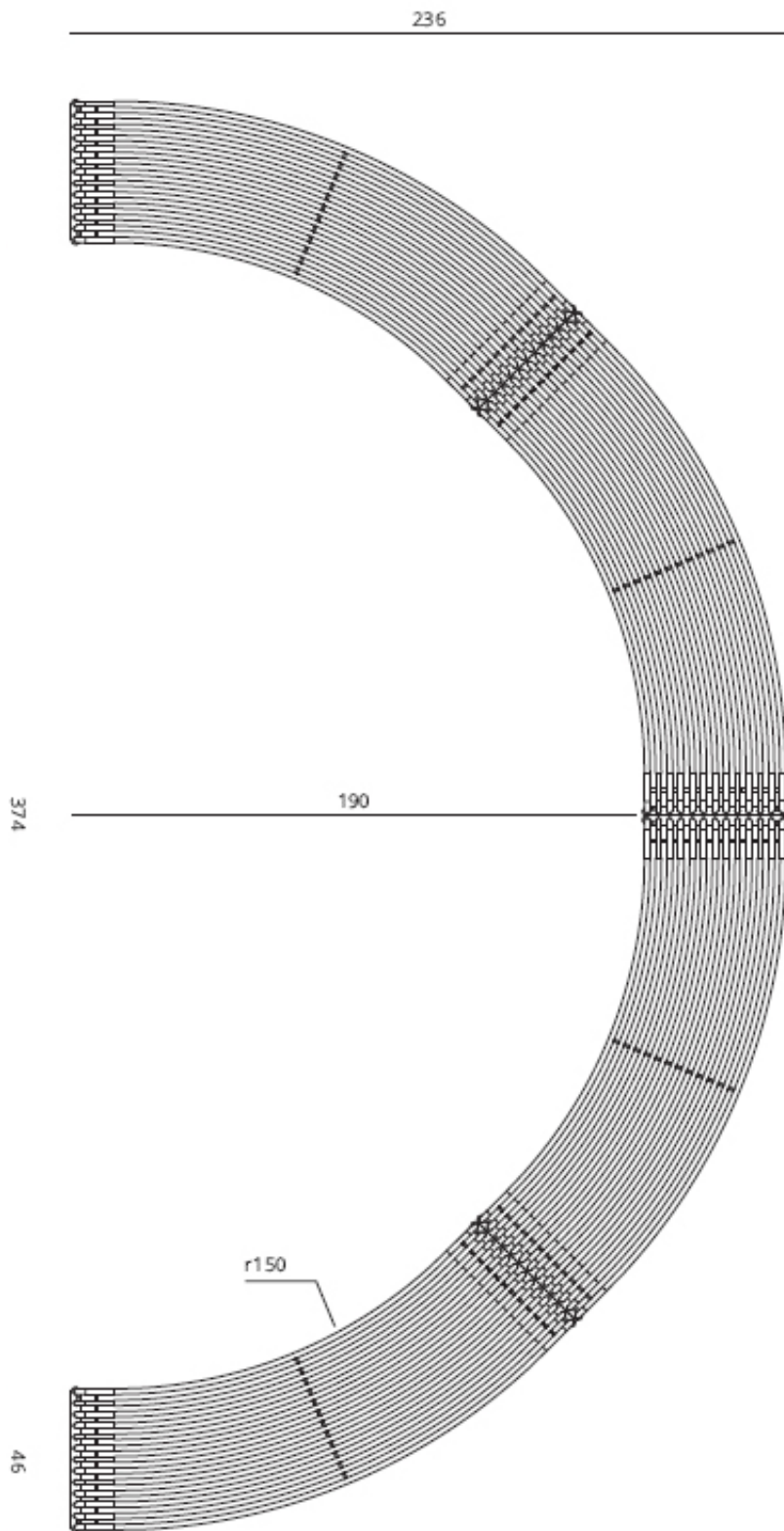

Example of 2 curved benches connected

SIERRA.015

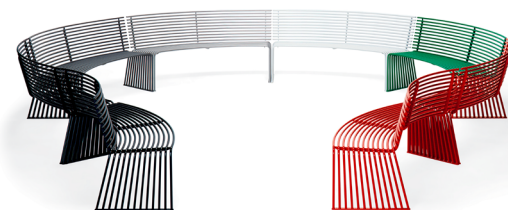

Benches with Backrest

DESIGN Basaglia & Rota Nodari



The Sierra.015 collection benches with backrests by Italian designers Basaglia & Rota Nodari are available in straight, convex curved & concave curved forms. The signature bent 18mm diameter pipes that shape their form, disperse heat in the summer without freezing over in the winter thanks to their hot-dip galvanized steel & hollow interior. Offered in satin stainless steel or polyester power-coating in a variety of colors. Ready-equipped for fastening to the ground with bolts or joined together using steel plates.



Structure: Hot-dip galvanized steel with matte polyester powder coat colors or a satin finish on select models
 Manufactured in Italy / Assembly: Product ships fully assembled / Ground Fixing: Bracket connected or ground-bolted
Freight: Not included in LIST Price - See freight table / GSA: Open Market

BASE MODEL	PART #	FINISH	LIST PRICE \$
Bench with backrest 	● XBS20-1	Black - Pantone Black, RAL 9005	\$4147
	● XBS20-2	Anthracite - Speckled texture, RAL 7024	\$4147
	○ XBS20-3	White - Pantone 705, RAL 9003	\$4147
	● XBS20-18	Corten - Speckled texture	\$4147
	● XBS20-5	Green - Pantone 349, RAL 6029	\$4147
	● XBS20-4	Red - Pantone 187, RAL 3000	\$4147
	● XBS20-11	Satin-finish on stainless steel	\$6743
Max Weight: 2500 lb			
Curved concave bench 	● XBC15-1	Black - Pantone Black, RAL 9005	\$5392
	● XBC15-2	Anthracite - Speckled texture, RAL 7024	\$5392
	○ XBC15-18	White - Pantone 705, RAL 9003	\$5392
	● XBC15-3	Corten - Speckled texture	\$5392
	● XBC15-5	Green - Pantone 349, RAL 6029	\$5392
	● XBC15-4	Red - Pantone 187, RAL 3000	\$5392
	● XBC15-11	Satin-finish on stainless steel	\$7687
Max Weight: 2500 lb			
Curved convex bench 	● XBX15-1	Black - Pantone Black, RAL 9005	\$5392
	● XBX15-18	Anthracite - Speckled texture, RAL 7024	\$5392
	○ XBX15-2	White - Pantone 705, RAL 9003	\$5392
	● XBX15-3	Corten - Speckled texture	\$5392
	● XBX15-5	Green - Pantone 349, RAL 6029	\$5392
	● XBX15-4	Red - Pantone 187, RAL 3000	\$5392
	● XBX15-11	Satin-finish on stainless steel	\$7687
Max Weight: 2500 lb			

Additional Options

Optional Skate Guards

OPTION	PART #	DESCRIPTION	LIST PRICE \$
Skate guard	-UT15	Skate guards to prevent people from grinding their skateboard on the furniture. Sold as a pack of 2 guards.	\$157

Product Assembly

OPTION	PART #	DESCRIPTION	LIST PRICE \$
Fully Assembled	-FA	Models arrive fully assembled.	\$0

Dimensions

The below dimensions were recorded by the URBANTIME® team using centimeters (cm) for distances & kilograms (kg) for product weight as the unit of measurement. Note, packaging not included.



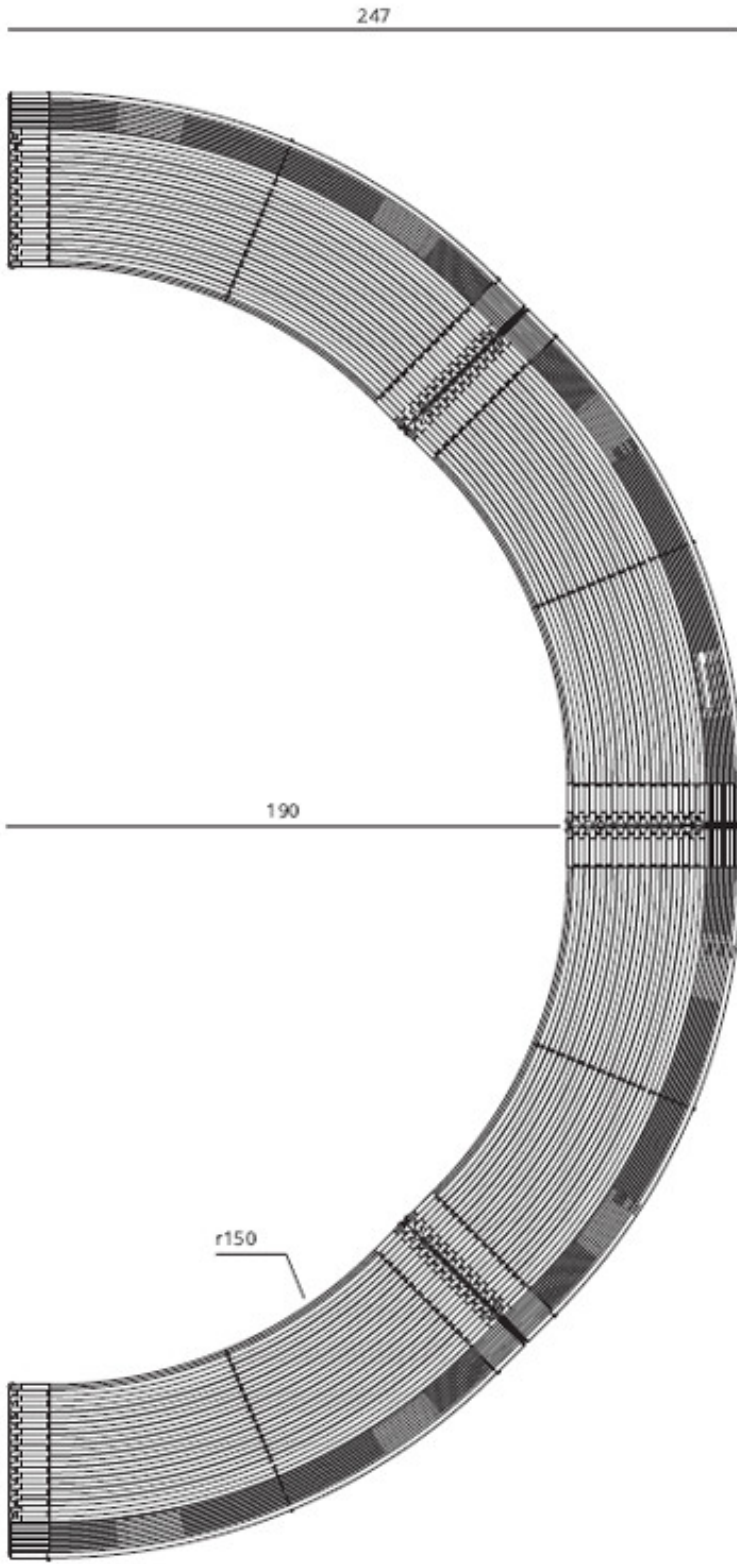

Example of 2 curved CONCAVE benches with backrests connected

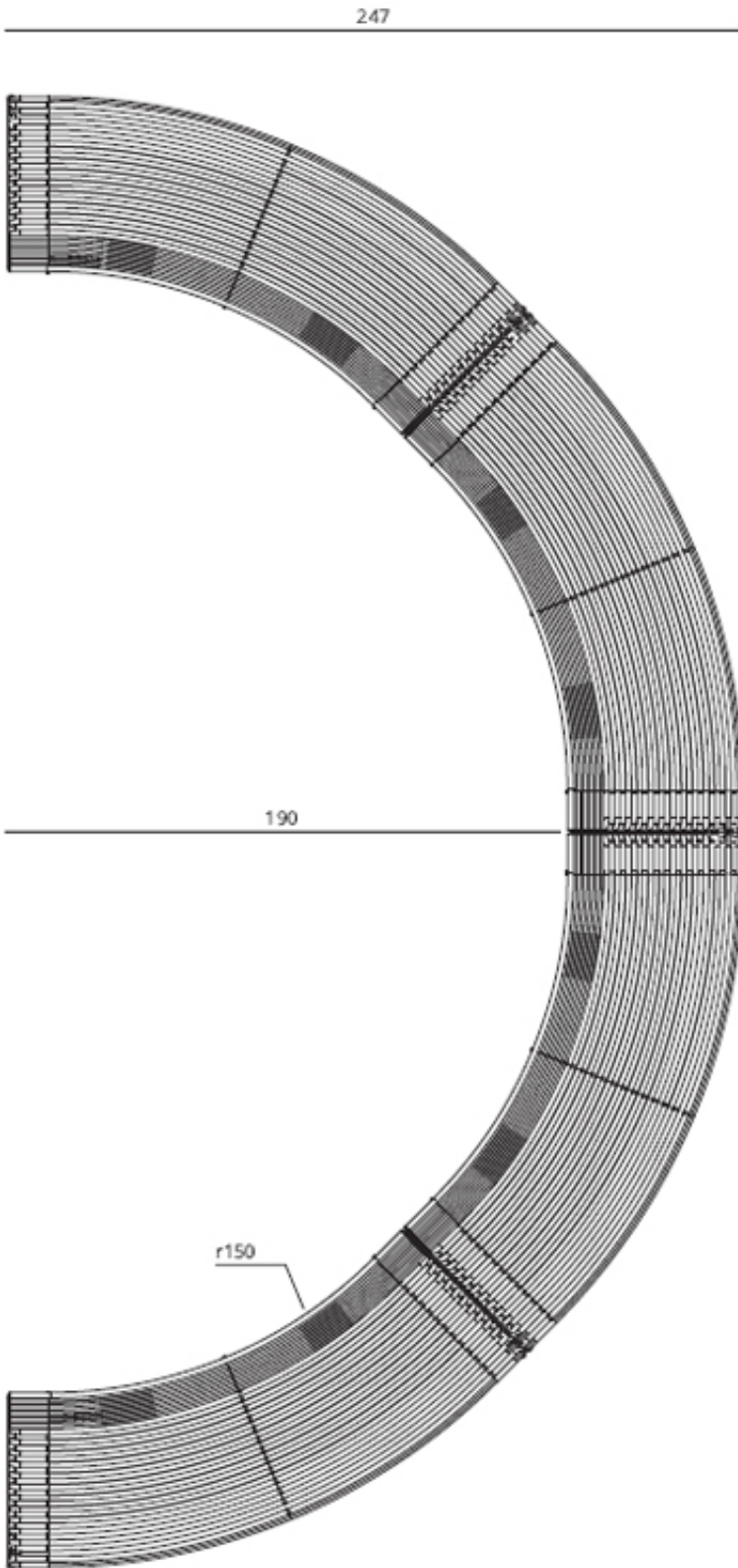

Example of 2 curved CONVEX benches with backrests connected

SIERRA.015

Tables

DESIGN Basaglia & Rota Nodari





The Sierra.015 collection tables by Italian designers Basaglia & Rota Nodari are available in straight and circular forms. The signature bent 18mm diameter pipes that shape their form, disperse heat in the summer without freezing over in the winter thanks to their hot-dip galvanized steel & hollow interior. Offered in satin or polyester power-coat colors. Ready-equipped for fastening to the ground with bolts or using bracket to join to select benches & chairs per table.

Structure: Hot-dip galvanized steel with matte polyester powder coat colors or a satin finish on select models

Manufactured in Italy / Assembly: Product ships fully assembled / Ground Fixing: Bracket connected or ground-bolted

Freight: Not included in LIST Price - See freight table / GSA: Open Market

BASE MODEL	PART #	FINISH	LIST PRICE \$
Rectangular table 	● XTV20-1	Black - Pantone Black, RAL 9005	\$9053
	● XTV20-2	Anthracite - Speckled texture, RAL 7024	\$9053
	● XTV20-3	White - Pantone 705, RAL 9003	\$9053
	● XTV20-18	Corten - Speckled texture	\$9053
	● XTV20-5	Green - Pantone 349, RAL 6029	\$9053
	● XTV20-4	Red - Pantone 187, RAL 3000	\$9053
	● XTV20-11	Satin-finish on stainless steel	\$9053
Round table 	● XOCT-1	Black - Pantone Black, RAL 9005	\$2638
	● XOCT-2	Anthracite - Speckled texture, RAL 7024	\$2638
	● XOCT-3	White - Pantone 705, RAL 9003	\$2638
	● XOCT-7	Light Blue - Pantone 5405, RAL 5023	\$2638
	● XOCT-5	Green - Pantone 349, RAL 6029	\$2638
	● XOCT-4	Red - Pantone 187, RAL 3000	\$2638
	● XOCT-6	Yellow - Pantone 124, RAL 1004	\$2638
Round table with small cubes & brackets 	● XOCT-XBC4-1	Black - Pantone Black, RAL 9005	\$7112
	● XOCT-XBC4-2	Anthracite - Speckled texture, RAL 7024	\$7112
	● XOCT-XBC4-3	Anthracite - Speckled texture, RAL 7024	\$7112
	● XOCT-XBC4-7	Light Blue - Pantone 5405, RAL 5023	\$7112
	● XOCT-XBC4-5	Green - Pantone 349, RAL 6029	\$7112
	● XOCT-XBC4-4	Red - Pantone 187, RAL 3000	\$7112
Max Weight: 2500 lb ● XOCT-XBC4-6 Yellow - Pantone 124, RAL 1004 \$7112			

Additional Options

N/A

Product Assembly

<i>OPTION</i>	<i>PART #</i>	<i>DESCRIPTION</i>	<i>LIST PRICE \$</i>
Fully Assembled	-FA	Models arrive fully assembled.	\$0

Dimensions

The below dimensions were recorded by the URBANTIME® team using centimeters (cm) for distances & kilograms (kg) for product weight as the unit of measurement. Note, packaging not included.

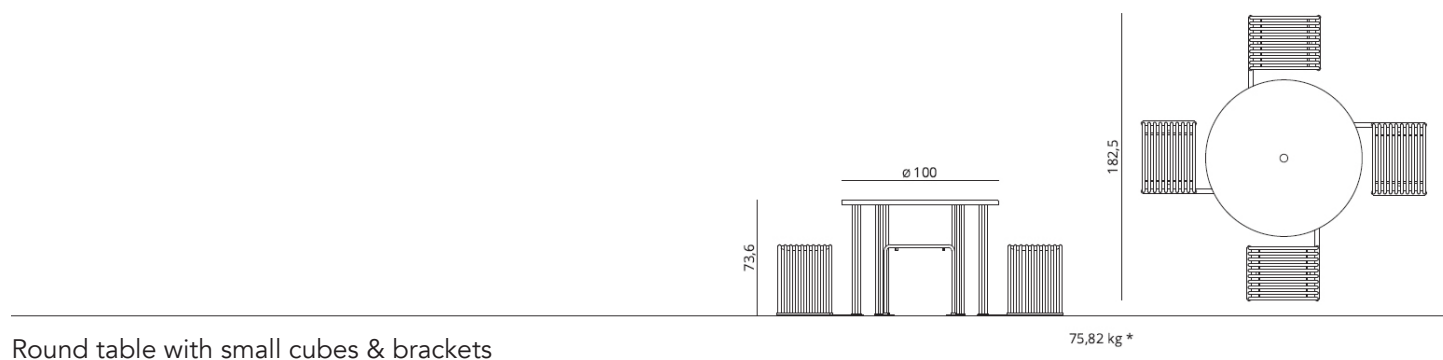

SIERRA.015

Connections for Flat Benches

DESIGN Basaglia & Rota Nodari

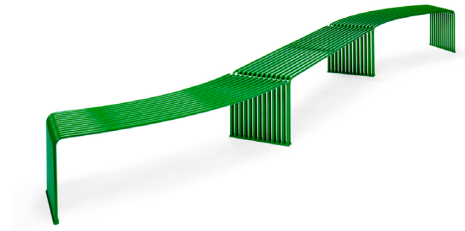



These Sierra.015 collection brackets allow backless benches to be connected to one another & to the rectangular table. Offered in polyester power-coat colors.

Structure: Hot-dip galvanized steel with matte polyester powder coat colors

Manufactured in Italy / Assembly: Some assembly required / Ground Fixing: Bracket connected

Freight: Not included in LIST Price - See freight table / GSA: Open Market

BASE MODEL	PART #	FINISH	LIST PRICE \$
End brackets for connecting backless benches XFS20 & XFC15 	● DLE25-1	Black - Pantone Black, RAL 9005	\$185
	● DLE25-2	Anthracite - Speckled texture, RAL 7024	\$185
	○ DLE25-3	White - Pantone 705, RAL 9003	\$185
	● DLE25-18	Corten - Speckled texture	\$185
	● DLE25-9	Green - Pantone 349, RAL 6029	\$185
	Note: Price per bracket	● DLE25-4	Red - Pantone 187, RAL 3000
Middle brackets for connecting backless benches XFS20 & XFC15 	● DLM25-1	Black - Pantone Black, RAL 9005	\$113
	● DLM25-2	Anthracite - Speckled texture, RAL 7024	\$113
	○ DLM25-3	White - Pantone 705, RAL 9003	\$113
	● DLM25-18	Corten - Speckled texture	\$113
	● DLM25-9	Green - Pantone 349, RAL 6029	\$113
	Note: Price per bracket	● DLM25-4	Red - Pantone 187, RAL 3000
Bracket to connect flat backless benches XFS20 to tables XTV20 	● DLF25-1	Black - Pantone Black, RAL 9005	\$426
	● DLF25-2	Anthracite - Speckled texture, RAL 7024	\$426
	○ DLF25-3	White - Pantone 705, RAL 9003	\$426
	● DLF25-18	Corten - Speckled texture	\$426
	● DLF25-9	Green - Pantone 349, RAL 6029	\$426
	Note: Price is for 2 brackets	● DLF25-4	Red - Pantone 187, RAL 3000

Examples

Connecting Benches to Benches

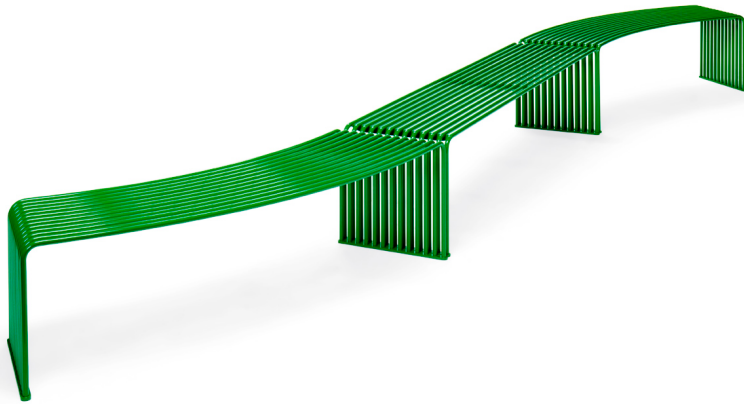
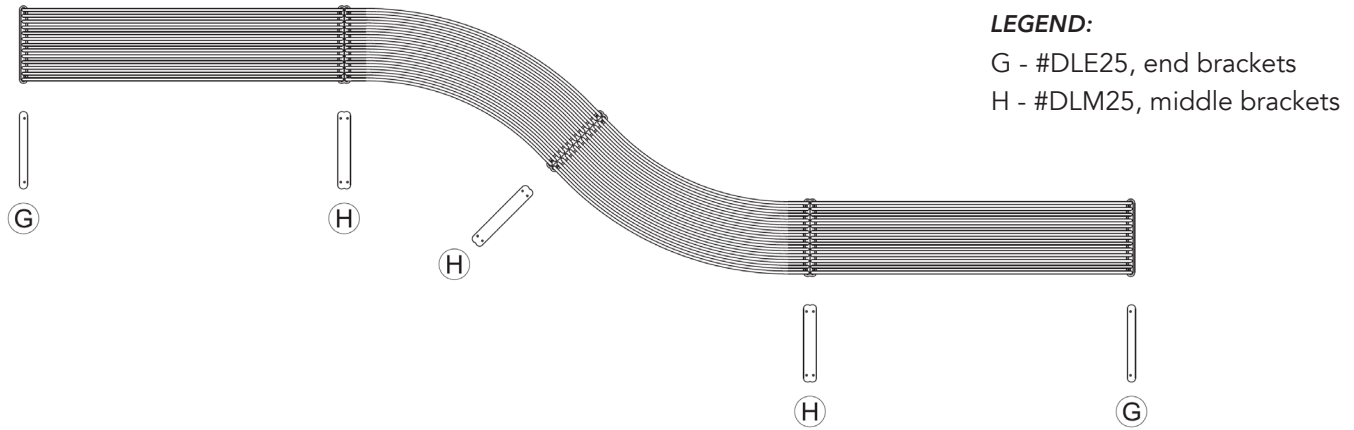

- < EXAMPLE MODELS:**
 XFS20-5 (x1) - backless bench
 XFC15-5 (x2) - curved backless bench
 DLE25-5 (x2) - end brackets
 DLM25 (x2) - middle brackets

Connecting Benches to Tables

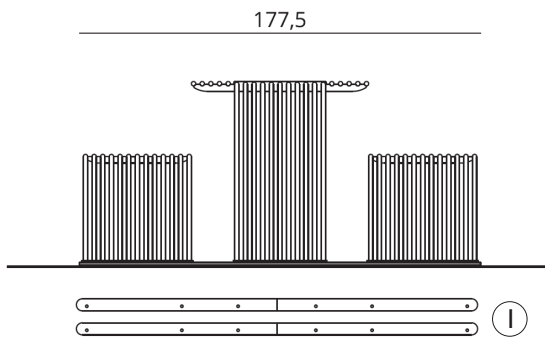

Product Assembly

OPTION	PART #	DESCRIPTION	LIST PRICE \$
Assembly Required	-AR	Models arrive requiring some assembly.	\$0

SIERRA.015

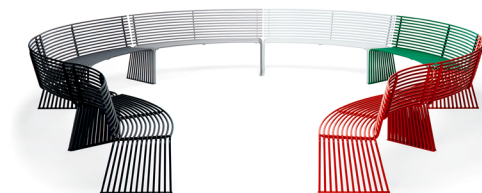

Connections for benches

DESIGN Basaglia & Rota Nodari



These Sierra.015 collection brackets allow benches with backrests to be connected to one another & to the rectangular table. Offered in polyester power-coat colors.

Structure: Hot-dip galvanized steel with matte polyester powder coat colors or heat transfer film faux wood effects
 Manufactured in Italy / Assembly: Some assembly required / Ground Fixing: Free-standing or ground-bolted
Freight: Not included in LIST Price - See freight table / GSA: Open Market

BASE MODEL	PART #	FINISH	LIST PRICE \$
End brackets for connecting benches XBS20, XBC15 & XBX15 	● DLE30-1	Black - Pantone Black, RAL 9005	\$242
	● DLE30-2	Anthracite - Speckled texture, RAL 7024	\$242
	○ DLE30-3	White - Pantone 705, RAL 9003	\$242
	● DLE30-18	Corten - Speckled texture	\$242
	● DLE30-9	Green - Pantone 349, RAL 6029	\$242
	Note: Price per bracket	● DLE30-4	Red - Pantone 187, RAL 3000
Middle brackets for connecting benches XBS20, XBC15 & XBX15 	● DLM30-1	Black - Pantone Black, RAL 9005	\$145
	● DLM30-2	Anthracite - Speckled texture, RAL 7024	\$145
	○ DLM30-3	White - Pantone 705, RAL 9003	\$145
	● DLM30-18	Corten - Speckled texture	\$145
	● DLM30-9	Green - Pantone 349, RAL 6029	\$145
	Note: Price per bracket	● DLM30-4	Red - Pantone 187, RAL 3000
Bracket to connect straight benches with backrests to XBS20 to table XTV20 	● DLF25-1	Black - Pantone Black, RAL 9005	\$426
	● DLF25-2	Anthracite - Speckled texture, RAL 7024	\$426
	○ DLF25-3	White - Pantone 705, RAL 9003	\$426
	● DLF25-18	Corten - Speckled texture	\$426
	● DLF25-9	Green - Pantone 349, RAL 6029	\$426
	Note: Price is for 2 brackets	● DLF25-4	Red - Pantone 187, RAL 3000

Examples

Connecting Benches to Benches

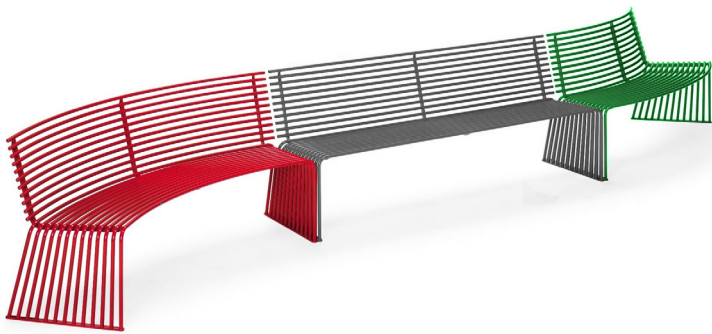
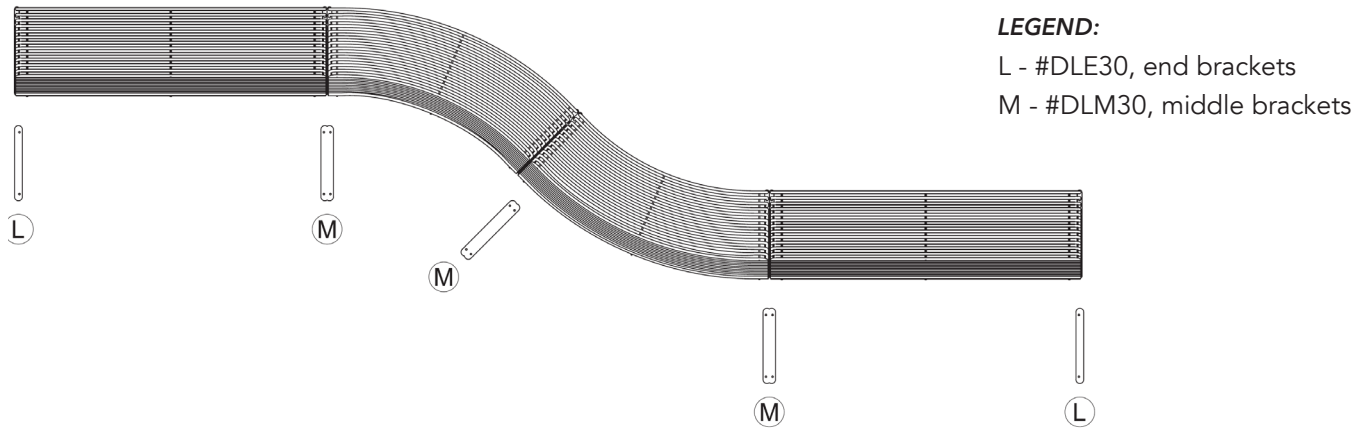

< **EXAMPLE MODELS:**

- XBS20-2 (x1) - straight bench with backrest
- XBC15-4 (x1) - concave bench with backrest
- XBX15-5 (x1) - convex bench with backrest
- DLM30 (x2) - middle brackets
- DLE30 (x2) - end brackets

Connecting Benches to Tables

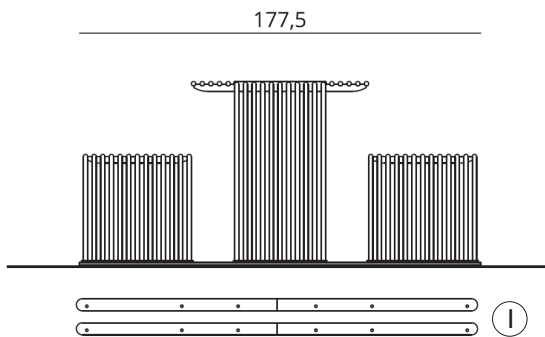

Product Assembly

OPTION	PART #	DESCRIPTION	LIST PRICE \$
Assembly Required	-AR	Models arrive requiring some assembly.	\$0

SIERRA.015

Chaise Lounge

DESIGN Basaglia & Rota Nodari





The Sierra.015 collection chaise lounge by Italian designers Basaglia & Rota Nodari offer the opportunity to lay back & relax outdoors. The signature bent 18mm diameter pipes that shape their form, disperse heat in the summer without freezing over in the winter thanks to their hot-dip galvanized steel & hollow interior. Offers on optional upholstered pillow to enhance the comfort. Ready-equipped for fastening to the ground with bolts.

Structure: Hot-dip galvanized steel with matte polyester powder coat colors or heat transfer film faux wood effects
 Manufactured in Italy / Assembly: Some assembly required / Ground Fixing: Free-standing or ground-bolted
Freight: Not included in LIST Price - See freight table / GSA: Open Market

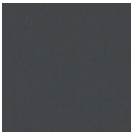

BASE MODEL	PART #	FINISH	LIST PRICE \$
 <p>Chaise lounge</p> <p>Max Weight: 2500 lb</p>	● XLC16-1	Black - Pantone Black, RAL 9005	\$3318
	● XLC16-2	Anthracite - Speckled texture, RAL 7024	\$3318
	○ XLC16-3	White - Pantone 705, RAL 9003	\$3318
	● XLC16-18	Corten - Speckled texture	\$3318
	● XLC16-5	Green - Pantone 349, RAL 6029	\$3318
	● XLC16-4	Red - Pantone 187, RAL 3000	\$3318
	● XLC16-6	Yellow - Pantone 124, RAL 1004	\$3318

Additional Options

Optional Upholstered Pillow

<i>OPTION</i>	<i>PART #</i>	<i>DESCRIPTION</i>	<i>LIST PRICE \$</i>
	-P1	Black vinyl pillow for outdoor use.	\$0
	-P2	Grey vinyl pillow for outdoor use.	\$0
	-P3	White vinyl pillow for outdoor use.	\$0
	-P4	Red vinyl pillow for outdoor use.	\$0

Optional Skate Guards

<i>OPTION</i>	<i>PART #</i>	<i>DESCRIPTION</i>	<i>LIST PRICE \$</i>
Skate guard 	-UT15	Skate guards to prevent people from grinding their skateboard on the furniture. Sold as a pack of 2 guards. 	\$157

Product Assembly

OPTION	PART #	DESCRIPTION	LIST PRICE \$
Fully Assembled	-FA	Models arrive fully assembled.	\$0

Dimensions

The below dimensions were recorded by the URBANTIME® team using centimeters (cm) for distances & kilograms (kg) for product weight as the unit of measurement. Note, packaging not included.

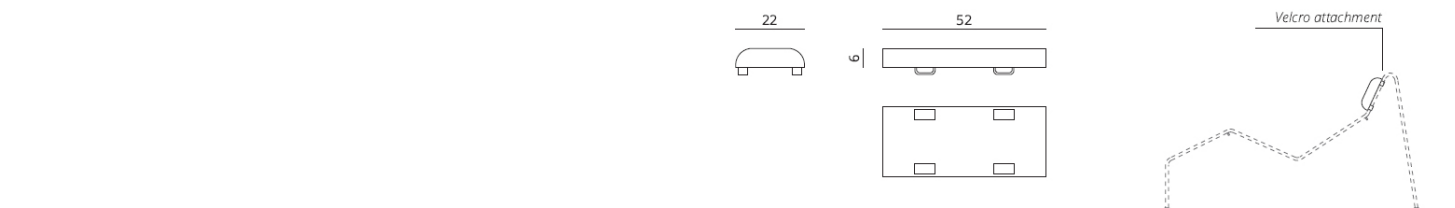



SIERRA.015



Bike racks

DESIGN Basaglia & Rota Nodari



The Sierra.015 collection bike racks by Italian designers Basaglia & Rota Nodari are offers in many shapes & sizes. The signature bent 18mm diameter pipes that shape their form, disperse heat in the summer without freezing over in the winter thanks to their hot-dip galvanized steel & hollow interior. Offered in polyester power-coating in a variety of colors. Ready-equipped for fastening to the ground.

Structure: Hot-dip galvanized steel with matte polyester powder coat colors or heat transfer film faux wood effects
 Manufactured in Italy / Assembly: Some assembly required / Ground Fixing: Free-standing or ground-bolted
Freight: Not included in LIST Price - See freight table / GSA: Open Market

BASE MODEL	PART #	FINISH	LIST PRICE \$
Low bike rack 	● XBIKE1-1	Black - Pantone Black, RAL 9005	\$510
	● XBIKE1-2	Anthracite - Speckled texture, RAL 7024	\$510
	○ XBIKE1-3	White - Pantone 705, RAL 9003	\$510
	● XBIKE1-18	Corten - Speckled texture	\$510
	● XBIKE1-5	Green - Pantone 349, RAL 6029	\$510
	● XBIKE1-4	Red - Pantone 187, RAL 3000	\$510
	Joined low bike racks including connecting brackets 	● XBIKE2-1	Black - Pantone Black, RAL 9005
● XBIKE2-2		Anthracite - Speckled texture, RAL 7024	\$2512
○ XBIKE2-18		White - Pantone 705, RAL 9003	\$2512
● XBIKE2-3		Corten - Speckled texture	\$2512
● XBIKE2-5		Green - Pantone 349, RAL 6029	\$2512
● XBIKE2-4		Red - Pantone 187, RAL 3000	\$2512
Tall pole bike rack 		● XBIKE3-1	Black - Pantone Black, RAL 9005
	● XBIKE3-18	Anthracite - Speckled texture, RAL 7024	\$708
	○ XBIKE3-2	White - Pantone 705, RAL 9003	\$708
	● XBIKE3-3	Corten - Speckled texture	\$708
	● XBIKE3-5	Green - Pantone 349, RAL 6029	\$708
	● XBIKE3-4	Red - Pantone 187, RAL 3000	\$708

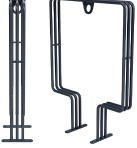
BASE MODEL	PART #	FINISH	LIST PRICE \$
Tall square bike rack 	● XBIKE4-1	Black - Pantone Black, RAL 9005	\$885
	● XBIKE4-2	Anthracite - Speckled texture, RAL 7024	\$885
	○ XBIKE4-3	White - Pantone 705, RAL 9003	\$885
	● XBIKE4-18	Corten - Speckled texture	\$885
	● XBIKE4-5	Green - Pantone 349, RAL 6029	\$885
	● XBIKE4-4	Red - Pantone 187, RAL 3000	\$885

Additional Options

N/A

Product Assembly

OPTION	PART #	DESCRIPTION	LIST PRICE \$
Fully Assembled	-FA	Models arrive fully assembled.	\$0

Dimensions

The below dimensions were recorded by the URBANTIME® team using centimeters (cm) for distances & kilograms (kg) for product weight as the unit of measurement. Note, packaging not included.



Low bike rack / Joined low bike racks (ie. 4 small bike racks joined together)



Tall pole bike rack / Tall square bike rack

SIERRA.015



Mounted litter bins

DESIGN Basaglia & Rota Nodari



The Sierra.015 collection litter bins by Italian designers Basaglia & Rota Nodari are available in a variety of solutions. Select between single, double or triple open top litter bins with 8-gallon capacity each. The signature bent 18mm diameter pipes that shape their form, disperse heat in the summer without freezing over in the winter thanks to their hot-dip galvanized steel & hollow interior. Ready-equipped for fastening to the ground.

Structure: Hot-dip galvanized steel with anthracite matte polyester powder coat
 Manufactured in Italy / Assembly: Fully assembled / Ground Fixing: Ground bolted
Freight: Not included in LIST Price - See freight table / GSA: Open Market

BASE MODEL	PART #	FINISH	LIST PRICE \$
Single ground bolted litter bin  Bin Capacity: 8 gallon/bin	● XSBP1-2	Anthracite - Speckled texture, RAL 7024	\$2593
Double ground bolted litter bin  Bin Capacity: 8 gallon/bin	● XDBP2-2	Anthracite - Speckled texture, RAL 7024	\$4527
Triple ground bolted litter bin  Bin Capacity: 8 gallon/bin	● XTBP3-2	Anthracite - Speckled texture, RAL 7024	\$6221

Additional Options

N/A

Product Assembly

<i>OPTION</i>	<i>PART #</i>	<i>DESCRIPTION</i>	<i>LIST PRICE \$</i>
Fully Assembled	-FA	Models arrive fully assembled.	\$0

Dimensions

The below dimensions were recorded by the URBANTIME® team using centimeters (cm) for distances & kilograms (kg) for product weight as the unit of measurement. Note, packaging not included.

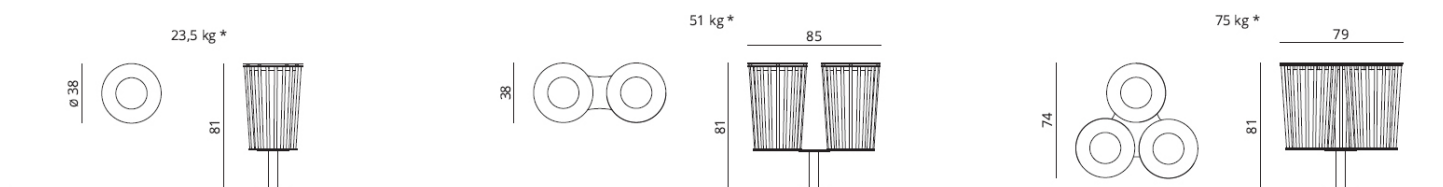

Single ground bolted litter bin / Double ground bolted litter bins / Triple ground bolted litter bins

SIERRA.015





















Mounted litter bins with lids

DESIGN Basaglia & Rota Nodari



The Sierra.015 collection litter bins by Italian designers Basaglia & Rota Nodari are available in a variety of solutions. Select between single, double or triple open top litter bins with option of different colored tops. The signature bent 18mm diameter pipes that shape their form, disperse heat in the summer without freezing over in the winter thanks to their hot-dip galvanized steel & hollow interior. Ready-equipped for fastening to the ground. 8 gallon capacity per bin.

Structure: Hot-dip galvanized steel with matte polyester powder coat colors
 Manufactured in Italy / Assembly: Fully assembled / Ground Fixing: Ground bolted
Freight: Not included in LIST Price - See freight table / GSA: Open Market

BASE MODEL	PART #	SIDE FINISH - TOP FINISH	LIST PRICE \$
Single ground bolted litter bin 	 XSTP1-2-2	Anthracite - Anthracite (RAL 7024)	\$2410
	 XSTP1-2-7	Anthracite - Blue (RAL 5023)	\$2410
	 XSTP1-2-6	Anthracite - Yellow (RAL 1004)	\$2410
Bin Capacity: 8 gallon/bin			
Double ground bolted litter bin 	 XDTP2-2-2-2	Anthracite - Anthracite / Anthracite	\$5144
	 XDTP2-2-7-7	Anthracite - Blue / Blue	\$5144
	 XDTP2-2-6-6	Anthracite - Yellow / Yellow	\$5144
	 XDTP2-2-2-7	Anthracite - Anthracite / Blue	\$5144
	 XDTP2-2-2-6	Anthracite - Anthracite / Yellow	\$5144
	 XDTP2-2-6-7	Anthracite - Yellow / Blue	\$5144
Bin Capacity: 8 gallon/bin			
Triple ground bolted litter bin 	 XTTP3-2-2-2-2	Anthracite - Anthracite / Anthracite / Anthracite	\$7289
	 XTTP3-2-7-7-7	Anthracite - Blue / Blue / Blue	\$7289
	 XTTP3-2-6-6-6	Anthracite - Yellow / Yellow / Yellow	\$7289
	 XTTP3-2-2-7-7	Anthracite - Anthracite / Blue / Blue	\$7289
	 XTTP3-2-2-6-6	Anthracite - Anthracite / Yellow / Yellow	\$7289
	 XTTP3-2-2-2-7	Anthracite - Anthracite / Anthracite / Blue	\$7289
	 XTTP3-2-2-2-6	Anthracite - Anthracite / Anthracite / Yellow	\$7289
	 XTTP3-2-6-6-7	Anthracite - Yellow / Yellow / Blue	\$7289
	 XTTP3-2-7-7-6	Anthracite - Blue / Blue / Yellow	\$7289
Bin Capacity: 8 gallon/bin			

Additional Options

Litter Bin Labels and/or Ashtrays

<i>OPTION</i>	<i>PART #</i>	<i>DESCRIPTION</i>	<i>LIST PRICE \$</i>
	● DL01	Stainless steel "Plastic" lid label.	\$0
	● DL02	Stainless steel "Waste" lid label.	\$0
	● DL03	Stainless steel "Aluminum" lid label.	\$0
	● DL04	Stainless steel "Paper" lid label.	\$0
	● DL05	Stainless steel "Organic Matter" lid label.	\$0
	● DLA1	Stainless steel "Plastic" lid label with ashtray.	\$128
	● DLA2	Stainless steel "Waste" lid label with ashtray.	\$128
	● DLA3	Stainless steel "Aluminum" lid label with ashtray.	\$128
	● DLA4	Stainless steel "Paper" lid label with ashtray.	\$128
	● DLA5	Stainless steel "Organic Matter" lid label with ashtray.	\$128

Additional Options

N/A

Product Assembly

OPTION	PART #	DESCRIPTION	LIST PRICE \$
Fully Assembled	-FA	Models arrive fully assembled.	\$0

Dimensions

The below dimensions were recorded by the URBANTIME® team using centimeters (cm) for distances & kilograms (kg) for product weight as the unit of measurement. Note, packaging not included.

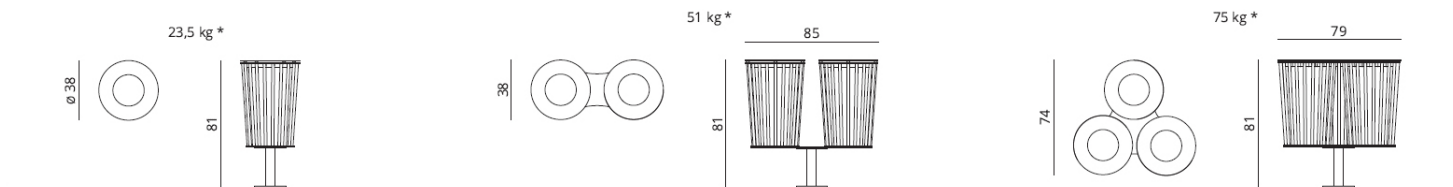

Single ground bolted litter bin / Double ground bolted litter bins / Triple ground bolted litter bins

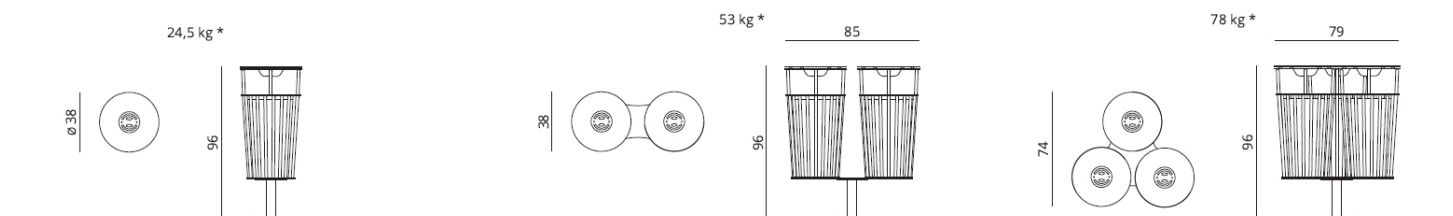

+ ashtrays



SIERRA.015



Large litter bins

DESIGN Basaglia & Rota Nodari











The Sierra.015 collection litter bins by Italian designers Basaglia & Rota Nodari are available in a variety of solutions. Select between open top or top with elevated lid large ground resting bins with 17-gallon capacity. The signature bent 18mm diameter pipes that shape their form, disperse heat in the summer without freezing over in the winter thanks to their hot-dip galvanized steel & hollow interior. Ready-equipped for fastening to the ground.

Structure: Hot-dip galvanized steel with matte polyester powder coat colors
 Manufactured in Italy / Assembly: Fully assembled / Ground Fixing: Free-standing or ground-bolted
Freight: Not included in LIST Price - See freight table / GSA: Open Market

BASE MODEL	PART #	SIDE FINISH - TOP FINISH	LIST PRICE \$
Large litter bin with an open top 	● XBBO1-2	Anthracite - Speckled texture, RAL 7024	\$2280
	○ XBBO1-3	White - Pantone 705, RAL 9003	\$2280
	● XBBO1-11	Satin-finish on stainless steel	\$3633
Bin Capacity: 17 gallon/bin			
Large litter bin with an elevated top 	● XBBC1-2	Anthracite - Speckled texture, RAL 7024	\$2376
	○ XBBC1-3	White - Pantone 705, RAL 9003	\$2376
	● XBBC1-11	Satin-finish on stainless steel	\$3729
Bin Capacity: 17 gallon/bin			

Additional Options

Litter Bin Labels and/or Ashtrays

<i>OPTION</i>	<i>PART #</i>	<i>DESCRIPTION</i>	<i>LIST PRICE \$</i>
	● DL01	Stainless steel "Plastic" lid label.	\$96
	● DL02	Stainless steel "Waste" lid label.	\$96
	● DL03	Stainless steel "Aluminum" lid label.	\$96
	● DL04	Stainless steel "Paper" lid label.	\$96
	● DL05	Stainless steel "Organic Matter" lid label.	\$96
	● DLA1	Stainless steel "Plastic" lid label with ashtray.	\$224
	● DLA2	Stainless steel "Waste" lid label with ashtray.	\$224
	● DLA3	Stainless steel "Aluminum" lid label with ashtray.	\$224
	● DLA4	Stainless steel "Paper" lid label with ashtray.	\$224
	● DLA5	Stainless steel "Organic Matter" lid label with ashtray.	\$224

Additional Options

N/A

Product Assembly

OPTION	PART #	DESCRIPTION	LIST PRICE \$
Fully Assembled	-FA	Models arrive fully assembled.	\$0

Dimensions

The below dimensions were recorded by the URBANTIME® team using centimeters (cm) for distances & kilograms (kg) for product weight as the unit of measurement. Note, packaging not included.

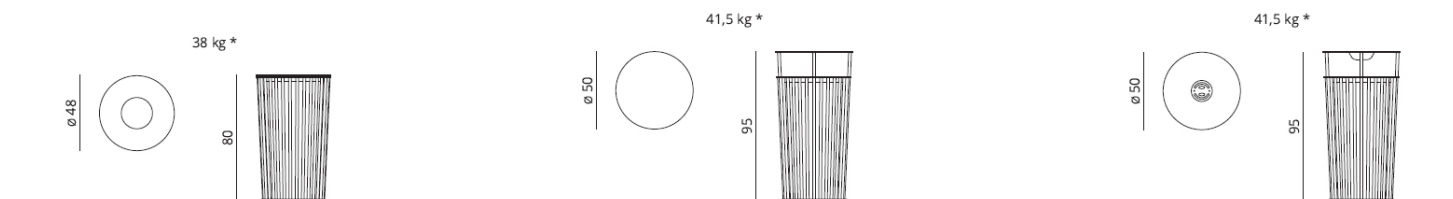

Large litter bin with an open top / Large litter bin with an elevated top / Large litter bin with an elevated top with ashtray

Freight

Order Qty	1	2	3	4	5	6	7	8	9	10
Cost/unit	\$1549.00	\$774.50	\$516.33	\$387.25	\$348.80	\$322.67	\$313.57	\$274.38	\$243.89	\$238.90
Total cost	\$1549	\$1549	\$1549	\$1549	\$1744	\$1936	\$2195	\$2195	\$2195	\$2389

Freight Calculation

- Freight costs are shown in **NET** pricing for most locations throughout the U.S. See cost/unit and total cost of freight by order quantity.
- Freight costs are calculated on Amalfi, Cortina.026, Sierra.015, Moon Tables & Tahoe.h24 orders.
- Eclipse Wired & Splash Air orders require a minimum order quantity of 10 & do not require additional freight costs to be calculated.
- Eclipse Wired & Splash Air products do not count toward the freight totals on mix outdoor collection orders.

Freight Terms

- The dealer is responsible for all storage or holding costs associated with freight delivery. Charges are non-negotiable for any shipping costs outside of Via Seating typical shipping. Including storage or holding costs, re-delivery charges, and change of address after shipment.
- Expedited freight for overnight, second and third day delivery are not available on outdoor products
- For order quantities over 20 or for additional freight related questions, please call 1-800-433-6614.
- For total freight costs of orders to Canada, South America, Mexico, Hawaii or Alaska, please call 1-800-433-6614.

Shipping

All URBANTIME® products ship directly from Italy to the job site on a 14 week minimum lead time.

Freight Claims

- All URBANTIME® outdoor landscape furniture products are carefully inspected and securely packed prior to leaving the Diemmebi facility by the Diemmebi/URBANTIME® team in Italy.
- All damage claims should be filed with Via Seating within five (5) days of receiving merchandise. The customer accepts responsibility for damage including concealed damage. Before accepting a shipment from the carrier, check for visible damage. Describe the visible damage on the freight carrier's delivery receipt. If damage is concealed, contact Via Seating without delay, requesting inspection. If this inspection is not obtainable, describe the damage in writing, giving the date the damaged product was received and file a claim with Via Seating. Include pictures.
- Claims must include a Returns Material Authorization (RMA) form.
- Returns are not accepted without prior consent from Via Seating and must have a Returns Material Authorization number assigned by Via Seating.
- Authorized returns are subject to a minimum 25% restocking charge depending on circumstances.
- Shipping costs for returned merchandise are the responsibility of the customer.

Warranty

See <https://www.viaseating.com/warranty>

Care & Maintenance

ISO standards BS EN ISO 12944-8 set guidelines for corrosion protection of steel. In order to maintain the effectiveness of this feature, it is highly recommended to execute the following procedures during product lifetime:

ORDINARY MAINTENANCE FOR PRODUCTS TREATED WITH HOT-DIP GALVANIZATION:

- Use low pressure cold water, at least 3 times a year.
- Use hot water (122-140° F / 50-60° C) and 3,5-4 bar pressure once a year.

The correct execution of ordinary maintenance determines the best conditions for the durability of the product and maintains the characteristics of protection of the steel intact over time. Omitting or limiting maintenance actions can accelerate product degradation.

Treatments & Surfaces

Hot-Dip Galvanized Steel

Amalfi, Cortina.026, Sierra.015 & Tahoe.h24 products undergo **hot-dip galvanization**, a treatment which consists of immersing the steel articles in a tank of molten zinc. The recommended temperature for the metal is 450° C. The level of the tank is adjusted daily by adding zinc and alloys with quality in compliance with UNI EN ISO 1461 and related standards. The aluminum frame and slats are coated with polyester powder paint. This guarantees excellent resistance to chemical and atmospheric agents. It is, therefore, suitable, above all, for finishing articles intended for outdoor use. The **polyester powder paints** provide excellent resistance to UV rays, atmospheric and chemical agents with high durability and no peeling. The final curing phase to ensure hardening takes place at high temperatures (around 170°).

Cataphoretic Coating

Splash Air & Eclipse Wired products utilize cataphoresis. **Cataphoretic coating** is a process in which articles are immersed in a bath of paint diluted with water and charged by an electric current, which completely coats the surfaces. This is one of the most eco-friendly, industrial painting systems and it also maintains excellent resistance to corrosion. Polyester powder paint guarantees excellent resistance to chemical and atmospheric agents.

Are the Products Corrosion-Resistant?

The products have obtained the corrosion resistance standards UNI EN ISO 9227:2012. The laboratory test, conducted in a neutral salt spray chamber, certifies the strength of the material and surface coatings, simulating their behavior in high-corrosion environments. Naturally, the elements must not be scratched or vandalized, otherwise the damaged areas will start rusting.

Can you sit on the products after prolonged exposure to the sun with high temperatures?

Yes, the products are empty inside. Further, products made of aluminum allow the heat to be more dissipated. We still encourage using caution for products in direct sunlight and/or within high temperatures.

Are Custom Colors Available?

Yes, with a minimum order quantity, surcharge and at an extended lead time. An exact RAL color and Area Manager approval is required. Please call us at 1-800-433-6614 or contact your Client Accounts Specialist for support.

Warranty (pg 1 of 2)

All URBANTIME® outdoor collections follow the Minimum Environmental Criteria (MEC), which is a eco-compatible design approach that establishes environmental requirements for designing furniture through its entire lifecycle. This includes screening all the furniture components & materials to prevent the use of harmful substances and creation of any harmful emissions (such as VOCs). It also ensures the product complies with the most recent UNI standards relating to durability, size, safety and robustness. These products are then further screened in the U.S. by Via Seating's Studio V » team to the ANSI/BIFMA e3-2019 Annex B- List of Chemicals of Concern and the California Proposition 65 List.

All URBANTIME® outdoor collections are tested by CATAS, an independent 3rd party testing lab in Italy, accredited by the Italian Accreditation Body, Accredia. Each outdoor furniture piece is certified for resistance to rust formation & are tested to withstand intensive cycles of salt spray. These products are then further tested in the U.S. annually by a 3rd party team of chemists & globally-recognized ISO 17025 accredited lab. They are rigorously tested for conformance to ANSI/BIFMA e3 standard credits 7.6.1, 7.6.2 and/or credit 7.6.3 as well as conformance to low-emitting materials.

Via Seating warrants to the initial purchaser, our products will be free from defects in material and craftsmanship for the extent of the applicable warranty period beginning from the date of the original sale.

Products covered by this warranty that were determined to be a result of a defect in material or craftsmanship will at Via Seating's discretion be repaired or replaced with a comparable product free of charge. Via will cover the labor costs of said repair with pre-approval. Repair or replacement of any defective part is the customer's exclusive remedy for any and all product defects.

The user shall be responsible for all maintenance service, which includes but not limited to: lubricating and cleaning of the product, assembly, adjustment, checking all screws every six months to ensure tightness and performing operation checks. This warranty applies to all Via Seating products manufactured after January 1, 2021 and shipped to the Contiguous US, Alaska, and Hawaii. There are no other warranties, expressed or implied, other than those specifically described here.

Warranty Periods

FIVE (5) YEAR WARRANTY COVERAGE

Amalfi, Cortina.026, Eclipse Wired, Moon Tables, Sierra.015, Splash Air & Tahoe.h24: covered for use within 75 miles of salt water and in full sunlight).

Via Seating reserves the right to make changes in design/construction and to discontinue products without prior notice.

Warranty (pg 2 of 2)

Warranty Exceptions

(ie. not covered under warranty)

- Graded-In, COM/COL textiles.
- Color-fastness or matching of colors patterns or dye lot, including; minor variations, color matches to swatches used for specification purposes and/or prior purchases.
- Products specified outside of those shown in the Via Seating price list.
- Products with unauthorized repair or alteration.
- Products not used, maintained or installed in accordance with Via Seating's applicable guidelines.
- Products exposed to conditions deemed extreme (i.e. environments other than "normal commercial, indoor office" spaces) and damage from sunlight and UV rays.
- Products purchased "as is" or second hand/refurbished products.
- Products sold by unauthorized dealers.
- Variations of leather; dye lots, environment marks, scars, bites, rubs, wrinkles, stretch marks, pattern markings and minor irregularities in color, surface, grain & texture.
- Samples, floor/showroom samples, road samples.
- Damage caused by the carrier in-transit, which will be handled as a separate claim against the carrier.
- Damage caused by staining, sharp objects, imprinting from instruments and water damage.

Claim Process

In order to process your warranty claim accurately and efficiently please enter your warranty claim through our website at: <https://viaseating.com/warranty/>

Changes to This Policy

We may revise and update this policy from time to time at our sole discretion. All changes are effective immediately when we post them. If changes are material to this policy, we will make every effort to notify you before these amendments enter into force. Your continued use of the Via Seating Services means you accept and agree to any modifications to this policy.

Contact Us

For any questions, please contact us at <https://viaseating.com/contact-us/>

Direct URL: www.viaseating.com/warranty



Installation Guidelines

Fixing & Safety

Is material for the installation supplied?

No, any fixing to the ground is the installer's responsibility.

Structural Tests

The seats have passed the structural tests designed for the benches with ground fixing (table 2 of the UNI 11306:2009 standard and table 1 of the EN 12727:2000 standard, 4th level). Tests available upon request.

Can the benches be installed in environments with extreme hot or cold temperatures?

Yes, the products have passed the heat and humidity cycle tests in the 'PTP 45' climatic chamber. You can request the test from Via Seating.

Benches Not Fixed to the Ground

Structural tests have assumed products will be fixed to the ground to ensure safety in all environments. The use of the products without fixing them to a solid ground surface remains at the discretion and responsibility of the client.

Products Requiring Assembly

See website or QR code next to each applicable model within this price book for detailed assembly directions on products requiring some assembly.

Ground Installation

It is the responsibility of the qualified installer to verify the particularities of the pavement and to choose the most suitable fixing methods. Via Inc. suggests the following procedure as an installation example only and declines any liability in case of damage to the products or to any underground utilities.

1. When you receive the goods and remove the packaging, taking care not to damage the finishes.
2. Place the product in the desired position and mark the positions of the holes.
3. Move the element and drill the pavement in the marked positions.
4. We recommend the use of wall plugs for M8 screws in case of installation on a hard surface.
5. In the absence of pavement, we recommend the construction of plinths provided with M8 anchor bolts.
6. Use stainless wall plugs if the bench is installed outdoors.
7. Proceed with tightening the screws.

Connection of Seating Product Not Fixed to the Pavement

For use in non-urban environments, linking plates are available to join the benches without fixing them to the ground. However, this type of installation is only recommended for select models connected by collection specific brackets. See options by applicable product in the pricing pages above.

Contacts & Useful Links

Outdoor Product Expert: Nora Fenlon, CCO, nora@viaseating.com

Find Your Rep: <https://viaseating.com/representatives/>

Explore Outdoor: <https://viaseating.com/outdoor/>

Contact Us: <https://viaseating.com/contact-us>





URBANTIME®

DIEMMEBI

Visit ViaSeating.com or call us at 800-433-6614.



pinterest.com/viaseating



instagram.com/via_seating



www.youtube.com/@via_seating

© Via Seating 2024. All rights reserved. Product specifications are subject to change without notice.

