



# TAHOE.h24

Cubes



DESIGN Basaglia & Rota Nodari



The Tahoe.h24 collection cubes by Italian designers Basaglia & Rota Nodari deliver a timeless, classic look enhanced by the use of 100% recyclable materials. Offered in two distinct styles: heat-transfer film wood grain effect slats & hot-dip galvanized steel metal framework or a full polyester-power coated dipped color look. Ready-equipped for fastening to the ground with bolts.

Structure: Hot-dip galvanized steel with matte polyester powder coat colors or heat transfer film faux wood effects  
 Manufactured in Italy / Assembly: Fully assembled / Ground Fixing: Free-standing or ground-bolted

**Freight: Not included in LIST Price - See freight table / GSA: Open Market**

BASE MODEL	PART #	FINISH	LIST PRICE \$
Color cube 	● TCCUBE-1	Black - Pantone Black, RAL 9005	\$1354
	● TCCUBE-2	Anthracite - Speckled texture, RAL 7024	\$1354
	○ TCCUBE-3	White - Pantone 705, RAL 9003	\$1354
	● TCCUBE-18	Corten - Speckled texture	\$1354
	● TCCUBE-9	Sand - Pantone Warm Grey 5 C, RAL 7032	\$1354
	● TCCUBE-4	Red - Pantone 187, RAL 3000	\$1354
Max Weight: 2500 lb			
Faux wood cube 	● TNCUBE-2-N	Anthracite framework with faux ash wood	\$1501
	● TNCUBE-2-NDO	Anthracite framework with faux dark oak wood	\$1501
	○ TNCUBE-3-N	White framework with faux ash wood	\$1501
	○ TNCUBE-3-NDO	White framework with faux dark oak wood	\$1501
	● TNCUBE-18-N	Corten framework with faux ash wood	\$1501
	● TNCUBE-18-NDO	Corten framework with faux dark oak wood	\$1501
Max Weight: 2500 lb			

## Additional Options

N/A

## Product Assembly

<i>OPTION</i>	<i>PART #</i>	<i>DESCRIPTION</i>	<i>LIST PRICE \$</i>
Fully Assembled	-FA	Models arrive fully assembled.	\$0

## Dimensions

The below dimensions were recorded by the URBANTIME® team using centimeters (cm) for distances & kilograms (kg) for product weight as the unit of measurement. Note, packaging not included.

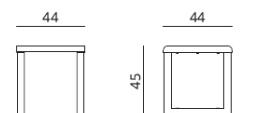

Cube chair

13,8 kg \*

# TAHOE.h24



Flat benches

DESIGN Basaglia & Rota Nodari



The Tahoe.h24 collection flat benches by Italian designers Basaglia & Rota Nodari deliver a timeless, classic look enhanced by the use of 100% recyclable materials. Available armless or with arms. Offered in two distinct styles: heat-transfer film wood grain effect slats & hot-dip galvanized steel metal framework or a full polyester-power coated dipped color look. Ready-equipped for fastening to the ground with bolts.

Structure: Hot-dip galvanized steel with matte polyester powder coat colors or heat transfer film faux wood effects  
 Manufactured in Italy / Assembly: Some assembly required / Ground Fixing: Free-standing or ground-bolted  
**Freight: Not included in LIST Price - See freight table** / GSA: Open Market

BASE MODEL	PART #	FINISH	LIST PRICE \$
Color flat bench 	● TFC15-1	Black - Pantone Black, RAL 9005	\$2694
	● TFC15-2	Anthracite - Speckled texture, RAL 7024	\$2694
	○ TFC15-3	White - Pantone 705, RAL 9003	\$2694
	● TFC15-18	Corten - Speckled texture	\$2694
	● TFC15-9	Sand - Pantone Warm Grey 5 C, RAL 7032	\$2694
	● TFC15-4	Red - Pantone 187, RAL 3000	\$2694
Max Weight: 2500 lb			
Faux wood flat bench 	● TFN15-2-N	Anthracite framework with faux ash wood	\$3009
	● TFN15-2-NDO	Anthracite framework with faux dark oak wood	\$3009
	○ TFN15-3-N	White framework with faux ash wood	\$3009
	○ TFN15-3-NDO	White framework with faux dark oak wood	\$3009
	● TFN15-18-N	Corten framework with faux ash wood	\$3009
	● TFN15-18-NDO	Corten framework with faux dark oak wood	\$3009
Max Weight: 2500 lb			

## Additional Options

OPTION	PART #	DESCRIPTION	LIST PRICE \$
Fixed arm	-AFB	Arm for the left side, right side or middle location on the flat bench.	\$340

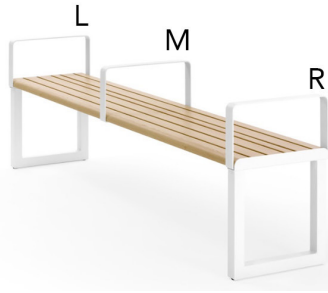

**EXAMPLE:**  
TFN15-3-N-AFB-3-AFB-3-AFB-3

## Product Assembly

OPTION	PART #	DESCRIPTION	LIST PRICE \$
Assembly Required	-AR	Models arrive requiring some assembly.	\$0

## Dimensions

The below dimensions were recorded by the URBANTIME® team using centimeters (cm) for distances & kilograms (kg) for product weight as the unit of measurement. Note, packaging not included.

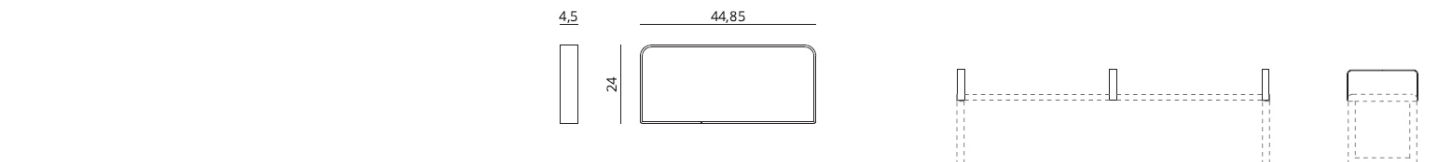

# TAHOE.h24















Benches with backrests

DESIGN Basaglia & Rota Nodari



The Tahoe.h24 collection benches with backrests by Italian designers Basaglia & Rota Nodari deliver a timeless, classic look enhanced by the use of 100% recyclable materials. Available armless or with arms. Offered in two distinct styles: heat-transfer film wood grain effect slats & hot-dip galvanized steel metal framework or a full polyester-power coated dipped color look. Ready-equipped for fastening to the ground with bolts.

Structure: Hot-dip galvanized steel with matte polyester powder coat colors or heat transfer film faux wood effects  
 Manufactured in Italy / Assembly: Some assembly required / Ground Fixing: Free-standing or ground-bolted  
**Freight: Not included in LIST Price - See freight table** / GSA: Open Market

BASE MODEL		PART #	FINISH	LIST PRICE \$
Color bench with backrest 		TBC20-1	Black - Pantone Black, RAL 9005	\$3630
		TBC20-2	Anthracite - Speckled texture, RAL 7024	\$3630
		TBC20-3	White - Pantone 705, RAL 9003	\$3630
		TBC20-18	Corten - Speckled texture	\$3630
		TBC20-9	Sand - Pantone Warm Grey 5 C, RAL 7032	\$3630
Max Weight: 2500 lb		TBC20-4	Red - Pantone 187, RAL 3000	\$3630
Faux wood bench with backrest 		TBN20-2-N	Anthracite framework with faux ash wood	\$4355
		TBN20-2-NDO	Anthracite framework with faux dark oak wood	\$4355
		TBN20-3-N	White framework with faux ash wood	\$4355
		TBN20-3-NDO	White framework with faux dark oak wood	\$4355
		TBN20-18-N	Corten framework with faux ash wood	\$4355
		TBN20-18-NDO	Corten framework with faux dark oak wood	\$4355
Max Weight: 2500 lb				

## Additional Options

OPTION	PART #	DESCRIPTION	LIST PRICE \$
Fixed arm	-ABB	Arm for either side of the bench with backrest.	\$340

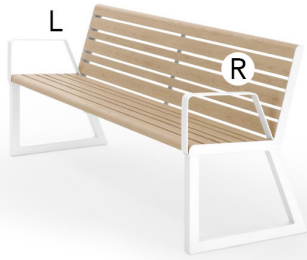

**EXAMPLE:**  
TBN20-3-N-ABB-3-ABB-3

## Product Assembly

OPTION	PART #	DESCRIPTION	LIST PRICE \$
Assembly Required	-AR	Models arrive requiring some assembly.	\$0

## Dimensions

The below dimensions were recorded by the URBANTIME® team using centimeters (cm) for distances & kilograms (kg) for product weight as the unit of measurement. Note, packaging not included.

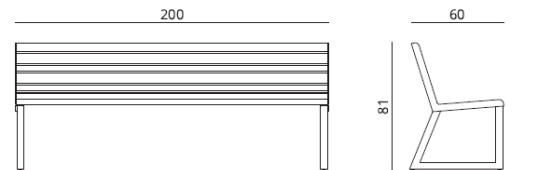

Bench with backrest

49 kg \*

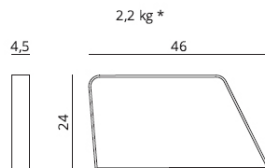

2,2 kg \*

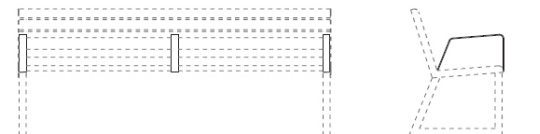

Optional armrest for bench with backrest

# TAHOE.h24





















Double seat benches

DESIGN Basaglia & Rota Nodari



The Tahoe.h24 collection double seat benches by Italian designers Basaglia & Rota Nodari deliver a timeless, classic look enhanced by the use of 100% recyclable materials. Offered in two distinct styles: heat-transfer film wood grain effect slats & hot-dip galvanized steel metal framework or a full polyester-power coated dipped color look. Ready-equipped for fastening to the ground with bolts.

Structure: Hot-dip galvanized steel with matte polyester powder coat colors or heat transfer film faux wood effects  
 Manufactured in Italy / Assembly: Some assembly required / Ground Fixing: Free-standing or ground-bolted  
**Freight: Not included in LIST Price - See freight table** / GSA: Open Market

BASE MODEL	PART #	FINISH	LIST PRICE \$
Color double seat bench 	 TBC15-1	Black - Pantone Black, RAL 9005	\$4460
	 TBC15-2	Anthracite - Speckled texture, RAL 7024	\$4460
	 TBC15-3	White - Pantone 705, RAL 9003	\$4460
	 TBC15-18	Corten - Speckled texture	\$4460
	 TBC15-9	Sand - Pantone Warm Grey 5 C, RAL 7032	\$4460
Max Weight: 2500 lb	 TBC15-4	Red - Pantone 187, RAL 3000	\$4460
Faux wood double seat bench 	  TBN15-2-N	Anthracite framework with faux ash wood	\$5392
	  TBN15-2-NDO	Anthracite framework with faux dark oak wood	\$5392
	  TBN15-3-N	White framework with faux ash wood	\$5392
	  TBN15-3-NDO	White framework with faux dark oak wood	\$5392
	  TBN15-18-N	Corten framework with faux ash wood	\$5392
	  TBN15-18-NDO	Corten framework with faux dark oak wood	\$5392
Max Weight: 2500 lb			



## Additional Options

OPTION	PART #	DESCRIPTION	LIST PRICE \$
Fixed arm	-ABB	Arm for either side of the double seat bench.	\$340

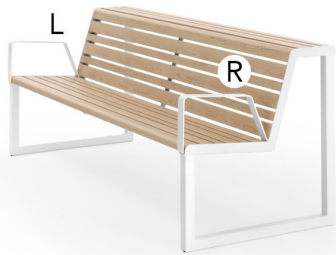

**EXAMPLE:**  
TBN15-3-N-ABB-3-ABB-3

## Product Assembly

OPTION	PART #	DESCRIPTION	LIST PRICE \$
Assembly Required	-AR	Models arrive requiring some assembly.	\$0

## Dimensions

The below dimensions were recorded by the URBANTIME® team using centimeters (cm) for distances & kilograms (kg) for product weight as the unit of measurement. Note, packaging not included.

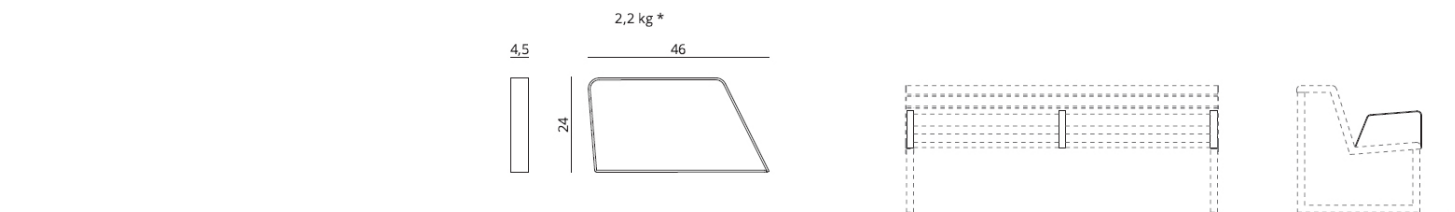

Optional armrest for double seat bench

# TAHOE.h24



Tables

DESIGN Basaglia & Rota Nodari



The Tahoe.h24 collection tables by Italian designers Basaglia & Rota Nodari deliver a timeless, classic look enhanced by the use of 100% recyclable materials. Available with optional umbrella hole or sun shade. Table offered in two distinct styles: heat-transfer film wood grain effect slats & hot-dip galvanized steel metal framework or a full polyester-power coated dipped color look. Ready-equipped for fastening to the ground with bolts.

Structure: Hot-dip galvanized steel with matte polyester powder coat colors or heat transfer film faux wood effects  
 Manufactured in Italy / Assembly: Some assembly required / Ground Fixing: Free-standing or ground-bolted  
**Freight: Not included in LIST Price - See freight table** / GSA: Open Market

BASE MODEL	PART #	FINISH	LIST PRICE \$
Color table 	● TTC25-1	Black - Pantone Black, RAL 9005	\$3785
	● TTC25-2	Anthracite - Speckled texture, RAL 7024	\$3785
	○ TTC25-3	White - Pantone 705, RAL 9003	\$3785
	● TTC25-18	Corten - Speckled texture	\$3785
	● TTC25-9	Sand - Pantone Warm Grey 5 C, RAL 7032	\$3785
	● TTC25-4	Red - Pantone 187, RAL 3000	\$3785
Max Weight: 2500 lb			
Faux wood table 	● TTN25-2-N	Anthracite framework with faux ash wood	\$4562
	● TTN25-2-NDO	Anthracite framework with faux dark oak wood	\$4562
	○ TTN25-3-N	White framework with faux ash wood	\$4562
	○ TTN25-3-NDO	White framework with faux dark oak wood	\$4562
	● TTN25-18-N	Corten framework with faux ash wood	\$4562
	● TTN25-18-NDO	Corten framework with faux dark oak wood	\$4562
Max Weight: 2500 lb			

## Additional Options

### Umbrella Hole

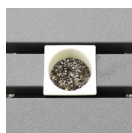
OPTION	PART #	DESCRIPTION	LIST PRICE \$
	H1	Center hole with a 2.2" x 2.2" round insert for placing an umbrella pole.	\$272

## Product Assembly

OPTION	PART #	DESCRIPTION	LIST PRICE \$
Assembly Required	-AR	Models arrive requiring some assembly.	\$0

## Dimensions

The below dimensions were recorded by the URBANTIME® team using centimeters (cm) for distances & kilograms (kg) for product weight as the unit of measurement. Note, packaging not included.

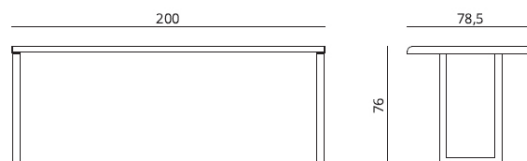

Table

50 kg \*

## TAHOE.h24

Tables + Integrated Benches

DESIGN Basaglia &amp; Rota Nodari



The Tahoe.h24 collection tables by Italian designers Basaglia & Rota Nodari deliver a timeless, classic look enhanced by the use of 100% recyclable materials. Available with optional umbrella hole or sun shade. Table offered in two distinct styles: heat-transfer film wood grain effect slats & hot-dip galvanized steel metal framework or a full polyester-power coated dipped color look. Ready-equipped for fastening to the ground with bolts.

Structure: Hot-dip galvanized steel with matte polyester powder coat colors or heat transfer film faux wood effects

Manufactured in Italy / Assembly: Some assembly required / Ground Fixing: Free-standing or ground-bolted

**Freight: Not included in LIST Price - See freight table** / GSA: Open Market

BASE MODEL	PART #	FINISH	LIST PRICE \$
Linking plate for connecting a flat backless bench to a table	● DLF15-1	Black - Pantone Black, RAL 9005	\$732
	● DLF15-2	Anthracite - Speckled texture, RAL 7024	\$732
	○ DLF15-3	White - Pantone 705, RAL 9003	\$732
	● DLF15-18	Corten - Speckled texture	\$732
	● DLF15-9	Sand - Pantone Warm Grey 5 C, RAL 7032	\$732
Note: Price 1 per side	● DLF15-4	Red - Pantone 187, RAL 3000	\$732
Linking plate for connecting a bench with a backrest to a table	● DL20-1	Black - Pantone Black, RAL 9005	\$800
	● DL20-2	Anthracite - Speckled texture, RAL 7024	\$800
	○ DL20-3	White - Pantone 705, RAL 9003	\$800
	● DL20-18	Corten - Speckled texture	\$800
	● DL20-9	Sand - Pantone Warm Grey 5 C, RAL 7032	\$800
Note: Price 1 per side	● DL20-4	Red - Pantone 187, RAL 3000	\$800
Linking plate for connecting a double seat bench to a table	● DL15-1	Black - Pantone Black, RAL 9005	\$840
	● DL15-2	Anthracite - Speckled texture, RAL 7024	\$840
	○ DL15-3	White - Pantone 705, RAL 9003	\$840
	● DL15-18	Corten - Speckled texture	\$840
	● DL15-9	Sand - Pantone Warm Grey 5 C, RAL 7032	\$840
Note: Price 1 per side	● DL15-4	Red - Pantone 187, RAL 3000	\$840

## Example



**< EXAMPLE MODELS:**

- TTN25-3-N (x1) - table
- TBN15-3-N (x2) - double seat benches
- DL15-3 (x2) - brackets

## Product Assembly

OPTION	PART #	DESCRIPTION	LIST PRICE \$
Assembly Required	-AR	Models arrive requiring some assembly.	\$0

## Dimensions

The below dimensions were recorded by the URBANTIME® team using centimeters (cm) for distances & kilograms (kg) for product weight as the unit of measurement. Note, packaging not included.

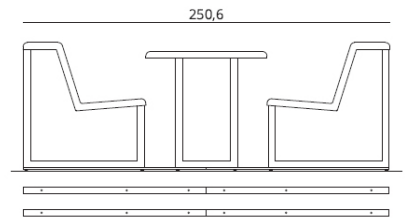
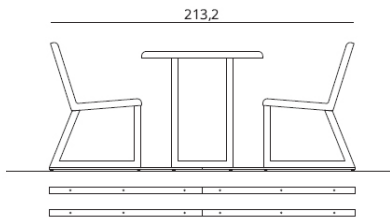
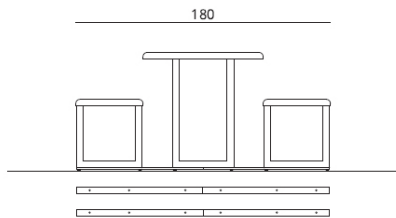

Same benches on either side of table

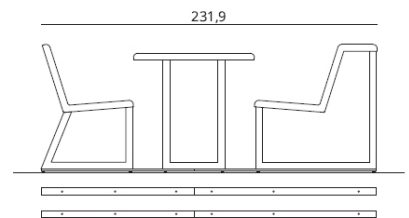
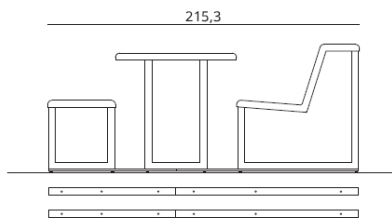
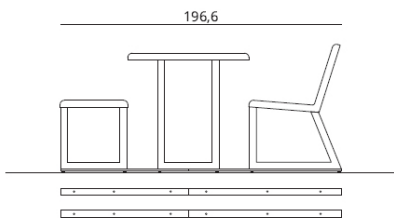

Different benches on either side of table

# TAHOE.h24



## Picnic Tables

DESIGN Basaglia & Rota Nodari



The Tahoe.h24 collection picnic tables by Italian designers Basaglia & Rota Nodari deliver a timeless, classic look enhanced by the use of 100% recyclable materials. Optional umbrella hole or sun shade. Offered in two distinct styles: heat-transfer film wood grain effect slats & hot-dip galvanized steel metal framework or a full polyester-power coated dipped color look. Ready-equipped for fastening to the ground with bolts.

Structure: Hot-dip galvanized steel with matte polyester powder coat colors or heat transfer film faux wood effects  
 Manufactured in Italy / Assembly: Some assembly required / Ground Fixing: Free-standing or ground-bolted  
**Freight: Not included in LIST Price - See freight table** / GSA: Open Market

BASE MODEL	PART #	FINISH	LIST PRICE \$
Color picnic table  Max Weight: 2500 lb	● TPC15-1	Black - Pantone Black, RAL 9005	\$6709
	● TPC15-2	Anthracite - Speckled texture, RAL 7024	\$6709
	○ TPC15-3	White - Pantone 705, RAL 9003	\$6709
	● TPC15-18	Corten - Speckled texture	\$6709
	● TPC15-9	Sand - Pantone Warm Grey 5 C, RAL 7032	\$6709
	● TPC15-4	Red - Pantone 187, RAL 3000	\$6709
	Faux wood picnic table  Max Weight: 2500 lb	● TPN15-2-N	Anthracite framework with faux ash wood
● TPN15-2-NDO		Anthracite framework with faux dark oak wood	\$8133
○ TPN15-3-N		White framework with faux ash wood	\$8133
○ TPN15-3-NDO		White framework with faux dark oak wood	\$8133
● TPN15-18-N		Corten framework with faux ash wood	\$8133
● TPN15-18-NDO		Corten framework with faux dark oak wood	\$8133

## Additional Options

### Umbrella Hole

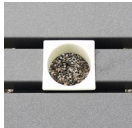
OPTION	PART #	DESCRIPTION	LIST PRICE \$
	H1	Center hole with a 2.2" x 2.2" round insert for placing an umbrella pole.	\$272

## Product Assembly

OPTION	PART #	DESCRIPTION	LIST PRICE \$
Assembly Required	-AR	Models arrive requiring some assembly.	\$0

## Dimensions

The below dimensions were recorded by the URBANTIME® team using centimeters (cm) for distances & kilograms (kg) for product weight as the unit of measurement. Note, packaging not included.

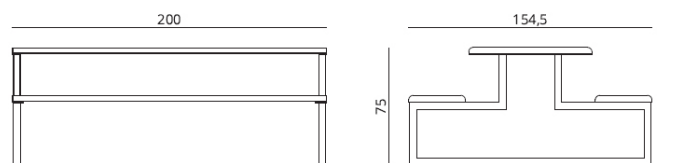

Picnic table

65 kg \*

# TAHOE.h24

“Miami” Sun Shade

DESIGN Basaglia & Rota Nodari



The Tahoe.h24 collection “Miami” sun shade by Italian designers Basaglia & Rota Nodari works on the table & picnic table models. It is composed of a sturdy, linear steel structure and a minimal design, carrying a large rectangular sheet. The cover, thanks to special brackets, can be anchored to all the tables of the Tahoe.h24 collection. The high-tech fabric is fireproof and has the ability to block 98% of harmful UV rays.

Structure: Framework treated with cathaphoresis & painted with matte polyester powder coat + canvas sun shade  
 Manufactured in Italy / Assembly: Some assembly required / Ground Fixing: Joined to table

**Freight: Not included in LIST Price - See freight table** / GSA: Open Market



BASE MODEL	PART #	FINISH	LIST PRICE \$
	● DSS1-1	Black - Pantone Black, RAL 9005	\$3349
	● DSS1-2	Anthracite - Speckled texture, RAL 7024	\$3349
	○ DSS1-3	White - Pantone 705, RAL 9003	\$3349
	● DSS1-18	Corten - Speckled texture	\$3349
	● DSS1-9	Sand - Pantone Warm Grey 5 C, RAL 7032	\$3349
	● DSS1-4	Red - Pantone 187, RAL 3000	\$3349



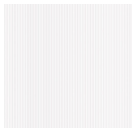

## Additional Options

### Sun Shade Colors

OPTION	PART #	DESCRIPTION	LIST PRICE \$
	DC1	Miami Sun Shade: White UV stabilized HDPE mesh, 100% polyethylene sun shade. Metal framework for shade included in price.	\$0
	DC2	Miami Sun Shade: Anthracite UV stabilized HDPE mesh, 100% polyethylene sun shade. Metal framework for shade included in price.	\$0

## Product Assembly

OPTION	PART #	DESCRIPTION	LIST PRICE \$
Assembly Required	-AR	Models arrive requiring some assembly.	\$0

## Dimensions

The below dimensions were recorded by the URBANTIME® team using centimeters (cm) for distances & kilograms (kg) for product weight as the unit of measurement. Note, packaging not included.

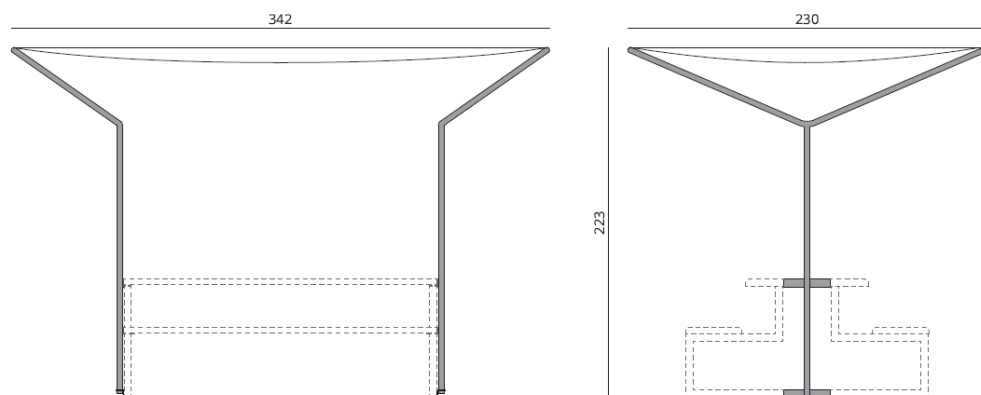

"Miami" Sun Shade

9,3 kg \*

# TAHOE.h24



## Chaise Lounges

DESIGN Basaglia & Rota Nodari





The Tahoe.h24 collection chaise lounge by Italian designers Basaglia & Rota Nodari deliver a timeless, classic look enhanced by the use of 100% recyclable materials. Available with an optional pillow to enhance the comfort. Offered in two distinct styles: heat-transfer film wood grain effect slats & hot-dip galvanized steel metal framework or a full polyester-power coated dipped color look. Ready-equipped for ground bolting.

Structure: Hot-dip galvanized steel with matte polyester powder coat colors or heat transfer film faux wood effects  
 Manufactured in Italy / Assembly: Some assembly required / Ground Fixing: Free-standing or ground-bolted  
**Freight: Not included in LIST Price - See freight table** / GSA: Open Market

BASE MODEL	PART #	FINISH	LIST PRICE \$
Color chaise lounge 	● TCH15-1	Black - Pantone Black, RAL 9005	\$5337
	● TCH15-2	Anthracite - Speckled texture, RAL 7024	\$5337
	○ TCH15-3	White - Pantone 705, RAL 9003	\$5337
	● TCH15-18	Corten - Speckled texture	\$5337
	● TCH15-9	Sand - Pantone Warm Grey 5 C, RAL 7032	\$5337
	● TCH15-4	Red - Pantone 187, RAL 3000	\$5337
Max Weight: 2500 lb			
Faux wood chaise lounge 	● TCN15-2-N	Anthracite framework with faux ash wood	\$5896
	● TCN15-2-NDO	Anthracite framework with faux dark oak wood	\$5896
	○ TCN15-3-N	White framework with faux ash wood	\$5896
	○ TCN15-3-NDO	White framework with faux dark oak wood	\$5896
	● TCN15-18-N	Corten framework with faux ash wood	\$5896
	● TCN15-18-NDO	Corten framework with faux dark oak wood	\$5896
Max Weight: 2500 lb			

## Additional Options

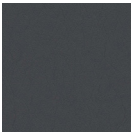
### Optional Upholstered Pillow

<i>OPTION</i>	<i>PART #</i>	<i>DESCRIPTION</i>	<i>LIST PRICE \$</i>
	P1	Black vinyl pillow for outdoor use.	\$0
	P2	Grey vinyl pillow for outdoor use.	\$0
	P3	White vinyl pillow for outdoor use.	\$0
	P4	Red vinyl pillow for outdoor use.	\$0

## Product Assembly

<i>OPTION</i>	<i>PART #</i>	<i>DESCRIPTION</i>	<i>LIST PRICE \$</i>
Assembly Required	-AR	Models arrive requiring some assembly.	\$0

## Dimensions

The below dimensions were recorded by the URBANTIME® team using centimeters (cm) for distances & kilograms (kg) for product weight as the unit of measurement. Note, packaging not included.

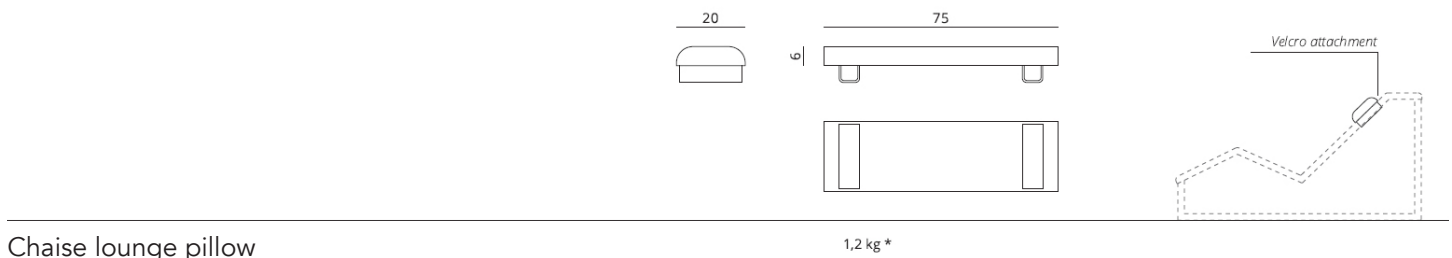

# TAHOE.h24



Swings

DESIGN Basaglia & Rota Nodari

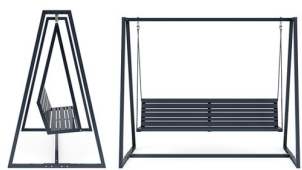

The Tahoe.h24 collection swings by Italian designers Basaglia & Rota Nodari deliver a timeless, classic look enhanced by the use of 100% recyclable materials. Offered in two distinct styles: heat-transfer film wood grain effect slats & hot-dip galvanized steel metal framework or a full polyester-power coated dipped color look. Ready-equipped for fastening to the ground with bolts.

Structure: Hot-dip galvanized steel with matte polyester powder coat colors or heat transfer film faux wood effects  
 Manufactured in Italy / Assembly: Some assembly required / Ground Fixing: Free-standing or ground-bolted  
**Freight: Not included in LIST Price - See freight table** / GSA: Open Market

BASE MODEL	PART #	FINISH	LIST PRICE \$
Color swing 	● TSC20-1	Black - Pantone Black, RAL 9005	\$10377
	● TSC20-2	Anthracite - Speckled texture, RAL 7024	\$10377
	○ TSC20-3	White - Pantone 705, RAL 9003	\$10377
	● TSC20-18	Corten - Speckled texture	\$10377
	● TSC20-9	Sand - Pantone Warm Grey 5 C, RAL 7032	\$10377
	● TSC20-4	Red - Pantone 187, RAL 3000	\$10377
Max Weight: 2500 lb			
Faux wood swing 	● TSN20-2-N	Anthracite framework with faux ash wood	\$11485
	● TSN20-2-NDO	Anthracite framework with faux dark oak wood	\$11485
	○ TSN20-3-N	White framework with faux ash wood	\$11485
	○ TSN20-3-NDO	White framework with faux dark oak wood	\$11485
	● TSN20-18-N	Corten framework with faux ash wood	\$11485
	● TSN20-18-NDO	Corten framework with faux dark oak wood	\$11485
Max Weight: 2500 lb			

## Additional Options

N/A

## Product Assembly

OPTION	PART #	DESCRIPTION	LIST PRICE \$
Assembly Required	-AR	Models arrive requiring some assembly.	\$0

## Dimensions

The below dimensions were recorded by the URBANTIME® team using centimeters (cm) for distances & kilograms (kg) for product weight as the unit of measurement. Note, packaging not included.

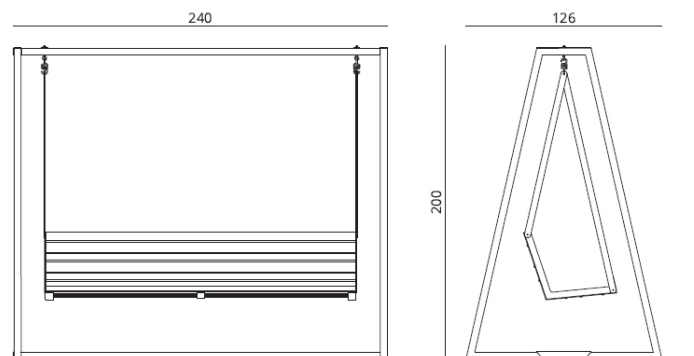

Swing

100 kg \*

# TAHOE.h24

Planters



DESIGN Basaglia & Rota Nodari



The Tahoe.h24 collection planters by Italian designers Basaglia & Rota Nodari deliver a timeless, classic look enhanced by the use of 100% recyclable materials. Offered in two distinct styles: heat-transfer film wood grain effect slats & hot-dip galvanized steel metal framework or a full polyester-power coated dipped color look. Ready-equipped for fastening to the ground with bolts.

Structure: Hot-dip galvanized steel with matte polyester powder coat colors or heat transfer film faux wood effects  
 Manufactured in Italy / Assembly: Fully assembled / Ground Fixing: Free-standing or ground-bolted

**Freight: Not included in LIST Price - See freight table / GSA: Open Market**

BASE MODEL	PART #	FINISH	LIST PRICE \$
 Color planter	● TGC15-1	Black - Pantone Black, RAL 9005	\$2135
	● TGC15-2	Anthracite - Speckled texture, RAL 7024	\$2135
	○ TGC15-3	White - Pantone 705, RAL 9003	\$2135
	● TGC15-18	Corten - Speckled texture	\$2135
	● TGC15-9	Sand - Pantone Warm Grey 5 C, RAL 7032	\$2135
	● TGC15-4	Red - Pantone 187, RAL 3000	\$2135
 Faux wood planter	● TGN15-2-N	Anthracite framework with faux ash wood	\$2643
	● TGN15-2-NDO	Anthracite framework with faux dark oak wood	\$2643
	○ TGN15-3-N	White framework with faux ash wood	\$2643
	○ TGN15-3-NDO	White framework with faux dark oak wood	\$2643
	● TGN15-18-N	Corten framework with faux ash wood	\$2643
	● TGN15-18-NDO	Corten framework with faux dark oak wood	\$2643

## Additional Options

N/A

## Product Assembly

OPTION	PART #	DESCRIPTION	LIST PRICE \$
Fully Assembled	-FA	Models arrive fully assembled.	\$0

## Dimensions

The below dimensions were recorded by the URBANTIME® team using centimeters (cm) for distances & kilograms (kg) for product weight as the unit of measurement. Note, packaging not included.

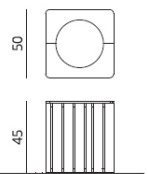

Planter

27 kg \*

# TAHOE.h24



## Big Litter Bins

DESIGN Basaglia & Rota Nodari



The Tahoe.h24 collection open-top litter bins by Italian designers Basaglia & Rota Nodari deliver a timeless, classic look enhanced by the use of 100% recyclable materials. Offered in two distinct styles: heat-transfer film wood grain effect slats & hot-dip galvanized steel metal framework or a full polyester-power coated dipped color look. Ready-equipped for fastening to the ground with bolts.

Structure: Hot-dip galvanized steel with matte polyester powder coat colors or heat transfer film faux wood effects  
 Manufactured in Italy / Assembly: Some assembly required / Ground Fixing: Free-standing or ground-bolted  
**Freight: Not included in LIST Price - See freight table** / GSA: Open Market

BASE MODEL	PART #	FINISH	LIST PRICE \$
Color litter bin  Bin Capacity: 17 gallon	● TLC15-1	Black - Pantone Black, RAL 9005	\$3762
	● TLC15-2	Anthracite - Speckled texture, RAL 7024	\$3762
	○ TLC15-3	White - Pantone 705, RAL 9003	\$3762
	● TLC15-18	Corten - Speckled texture	\$3762
	● TLC15-9	Sand - Pantone Warm Grey 5 C, RAL 7032	\$3762
	● TLC15-4	Red - Pantone 187, RAL 3000	\$3762
Faux wood litter bin  Bin Capacity: 17 gallon	● TLN15-2-N	Anthracite framework with faux ash wood	\$4269
	● TLN15-2-NDO	Anthracite framework with faux dark oak wood	\$4269
	○ TLN15-3-N	White framework with faux ash wood	\$4269
	○ TLN15-3-NDO	White framework with faux dark oak wood	\$4269
	● TLN15-18-N	Corten framework with faux ash wood	\$4269
	● TLN15-18-NDO	Corten framework with faux dark oak wood	\$4269



## Additional Options

N/A

## Product Assembly

OPTION	PART #	DESCRIPTION	LIST PRICE \$
Assembly Required	-AR	Models arrive requiring some assembly.	\$0

## Dimensions

The below dimensions were recorded by the URBANTIME® team using centimeters (cm) for distances & kilograms (kg) for product weight as the unit of measurement. Note, packaging not included.

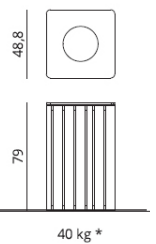

Litter Bins

# TAHOE.h24

Big Litter Bins with Lids

DESIGN Basaglia & Rota Nodari





The Tahoe.h24 collection open-top litter bins with lids by Italian designers Basaglia & Rota Nodari deliver a timeless, classic look enhanced by the use of 100% recyclable materials. Offered in two distinct styles: heat-transfer film wood grain effect slats & hot-dip galvanized steel metal framework or a full polyester-power coated dipped color look. Ready-equipped for fastening to the ground with bolts.

Structure: Hot-dip galvanized steel with matte polyester powder coat colors or heat transfer film faux wood effects

Manufactured in Italy / Assembly: Fully assembled / Ground Fixing: Free-standing or ground-bolted

**Freight: Not included in LIST Price - See freight table** / GSA: Open Market

BASE MODEL	PART #	FINISH	LIST PRICE \$
 Color litter bin with lid Bin Capacity: 17 gallon	● TLC20-1	Black - Pantone Black, RAL 9005	\$4128
	● TLC20-2	Anthracite - Speckled texture, RAL 7024	\$4128
	○ TLC20-3	White - Pantone 705, RAL 9003	\$4128
	● TLC20-18	Corten - Speckled texture	\$4128
	● TLC20-9	Sand - Pantone Warm Grey 5 C, RAL 7032	\$4128
	● TLC20-4	Red - Pantone 187, RAL 3000	\$4128
 Faux wood litter bin with lid Bin Capacity: 17 gallon	● TLN20-2-N	Anthracite framework with faux ash wood	\$4637
	● TLN20-2-NDO	Anthracite framework with faux dark oak wood	\$4637
	○ TLN20-3-N	White framework with faux ash wood	\$4637
	○ TLN20-3-NDO	White framework with faux dark oak wood	\$4637
	● TLN20-18-N	Corten framework with faux ash wood	\$4637
	● TLN20-18-NDO	Corten framework with faux dark oak wood	\$4637

## Additional Options

### Litter Bin Labels and/or Ashtrays

OPTION	PART #	DESCRIPTION	LIST PRICE \$
	● DL01	Stainless steel "Plastic" lid label.	\$0
	● DL02	Stainless steel "Waste" lid label.	\$0
	● DL03	Stainless steel "Aluminum" lid label.	\$0
	● DL04	Stainless steel "Paper" lid label.	\$0
	● DL05	Stainless steel "Organic Matter" lid label.	\$0
	● DLA1	Stainless steel "Plastic" lid label with ashtray.	\$128
	● DLA2	Stainless steel "Waste" lid label with ashtray.	\$128
	● DLA3	Stainless steel "Aluminum" lid label with ashtray.	\$128
	● DLA4	Stainless steel "Paper" lid label with ashtray.	\$128
	● DLA5	Stainless steel "Organic Matter" lid label with ashtray.	\$128

## Product Assembly

<i>OPTION</i>	<i>PART #</i>	<i>DESCRIPTION</i>	<i>LIST PRICE \$</i>
Fully Assembled	-FA	Models arrive fully assembled.	\$0

## Dimensions

The below dimensions were recorded by the URBANTIME® team using centimeters (cm) for distances & kilograms (kg) for product weight as the unit of measurement. Note, packaging not included.

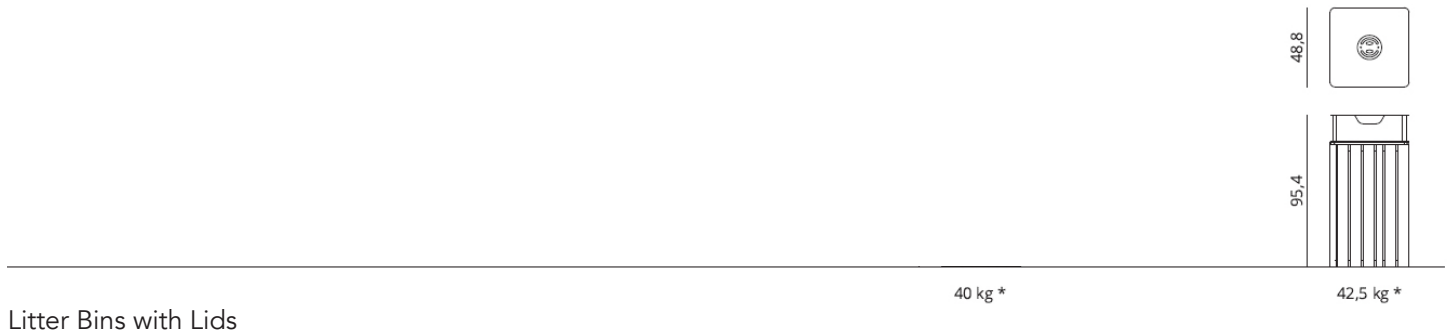

## Freight

Order Qty	1	2	3	4	5	6	7	8	9	10
Cost/unit	\$1549.00	\$774.50	\$516.33	\$387.25	\$348.80	\$322.67	\$313.57	\$274.38	\$243.89	\$238.90
Total cost	\$1549	\$1549	\$1549	\$1549	\$1744	\$1936	\$2195	\$2195	\$2195	\$2389

### Freight Calculation

- Freight costs are shown in **NET** pricing for most locations throughout the U.S. See cost/unit and total cost of freight by order quantity.
- Freight costs are calculated on Amalfi, Cortina.026, Sierra.015, Moon Tables & Tahoe.h24 orders.
- Eclipse Wired & Splash Air orders require a minimum order quantity of 10 & do not require additional freight costs to be calculated.
- Eclipse Wired & Splash Air products do not count toward the freight totals on mix outdoor collection orders.

### Freight Terms

- The dealer is responsible for all storage or holding costs associated with freight delivery. Charges are non-negotiable for any shipping costs outside of Via Seating typical shipping. Including storage or holding costs, re-delivery charges, and change of address after shipment.
- Expedited freight for overnight, second and third day delivery are not available on outdoor products
- For order quantities over 20 or for additional freight related questions, please call 1-800-433-6614.
- For total freight costs of orders to Canada, South America, Mexico, Hawaii or Alaska, please call 1-800-433-6614.

### Shipping

All URBANTIME® products ship directly from Italy to the job site on a 14 week minimum lead time.

### Freight Claims

- All URBANTIME® outdoor landscape furniture products are carefully inspected and securely packed prior to leaving the Diemmebi facility by the Diemmebi/URBANTIME® team in Italy.
- All damage claims should be filed with Via Seating within five (5) days of receiving merchandise. The customer accepts responsibility for damage including concealed damage. Before accepting a shipment from the carrier, check for visible damage. Describe the visible damage on the freight carrier's delivery receipt. If damage is concealed, contact Via Seating without delay, requesting inspection. If this inspection is not obtainable, describe the damage in writing, giving the date the damaged product was received and file a claim with Via Seating. Include pictures.
- Claims must include a Returns Material Authorization (RMA) form.
- Returns are not accepted without prior consent from Via Seating and must have a Returns Material Authorization number assigned by Via Seating.
- Authorized returns are subject to a minimum 25% restocking charge depending on circumstances.
- Shipping costs for returned merchandise are the responsibility of the customer.

### Warranty

See <https://www.viaseating.com/warranty>

## Care & Maintenance

ISO standards BS EN ISO 12944-8 set guidelines for corrosion protection of steel. In order to maintain the effectiveness of this feature, it is highly recommended to execute the following procedures during product lifetime:

### ORDINARY MAINTENANCE FOR PRODUCTS TREATED WITH HOT-DIP GALVANIZATION:

- Use low pressure cold water, at least 3 times a year.
- Use hot water (122-140° F / 50-60° C) and 3,5-4 bar pressure once a year.

The correct execution of ordinary maintenance determines the best conditions for the durability of the product and maintains the characteristics of protection of the steel intact over time. Omitting or limiting maintenance actions can accelerate product degradation.

## Treatments & Surfaces

### Hot-Dip Galvanized Steel

Amalfi, Cortina.026, Sierra.015 & Tahoe.h24 products undergo **hot-dip galvanization**, a treatment which consists of immersing the steel articles in a tank of molten zinc. The recommended temperature for the metal is 450° C. The level of the tank is adjusted daily by adding zinc and alloys with quality in compliance with UNI EN ISO 1461 and related standards. The aluminum frame and slats are coated with polyester powder paint. This guarantees excellent resistance to chemical and atmospheric agents. It is, therefore, suitable, above all, for finishing articles intended for outdoor use. The **polyester powder paints** provide excellent resistance to UV rays, atmospheric and chemical agents with high durability and no peeling. The final curing phase to ensure hardening takes place at high temperatures (around 170°).

### Cataphoretic Coating

Splash Air & Eclipse Wired products utilize cataphoresis. **Cataphoretic coating** is a process in which articles are immersed in a bath of paint diluted with water and charged by an electric current, which completely coats the surfaces. This is one of the most eco-friendly, industrial painting systems and it also maintains excellent resistance to corrosion. Polyester powder paint guarantees excellent resistance to chemical and atmospheric agents.

### Are the Products Corrosion-Resistant?

The products have obtained the corrosion resistance standards UNI EN ISO 9227:2012. The laboratory test, conducted in a neutral salt spray chamber, certifies the strength of the material and surface coatings, simulating their behavior in high-corrosion environments. Naturally, the elements must not be scratched or vandalized, otherwise the damaged areas will start rusting.

### Can you sit on the products after prolonged exposure to the sun with high temperatures?

Yes, the products are empty inside. Further, products made of aluminum allow the heat to be more dissipated. We still encourage using caution for products in direct sunlight and/or within high temperatures.

### Are Custom Colors Available?

Yes, with a minimum order quantity, surcharge and at an extended lead time. An exact RAL color and Area Manager approval is required. Please call us at 1-800-433-6614 or contact your Client Accounts Specialist for support.

## Warranty (pg 1 of 2)

All URBANTIME® outdoor collections follow the Minimum Environmental Criteria (MEC), which is a eco-compatible design approach that establishes environmental requirements for designing furniture through its entire lifecycle. This includes screening all the furniture components & materials to prevent the use of harmful substances and creation of any harmful emissions (such as VOCs). It also ensures the product complies with the most recent UNI standards relating to durability, size, safety and robustness. These products are then further screened in the U.S. by Via Seating's Studio V » team to the ANSI/BIFMA e3-2019 Annex B- List of Chemicals of Concern and the California Proposition 65 List.

All URBANTIME® outdoor collections are tested by CATAS, an independent 3rd party testing lab in Italy, accredited by the Italian Accreditation Body, Accredia. Each outdoor furniture piece is certified for resistance to rust formation & are tested to withstand intensive cycles of salt spray. These products are then further tested in the U.S. annually by a 3rd party team of chemists & globally-recognized ISO 17025 accredited lab. They are rigorously tested for conformance to ANSI/BIFMA e3 standard credits 7.6.1, 7.6.2 and/or credit 7.6.3 as well as conformance to low-emitting materials.

Via Seating warrants to the initial purchaser, our products will be free from defects in material and craftsmanship for the extent of the applicable warranty period beginning from the date of the original sale.

Products covered by this warranty that were determined to be a result of a defect in material or craftsmanship will at Via Seating's discretion be repaired or replaced with a comparable product free of charge. Via will cover the labor costs of said repair with pre-approval. Repair or replacement of any defective part is the customer's exclusive remedy for any and all product defects.

The user shall be responsible for all maintenance service, which includes but not limited to: lubricating and cleaning of the product, assembly, adjustment, checking all screws every six months to ensure tightness and performing operation checks. This warranty applies to all Via Seating products manufactured after January 1, 2021 and shipped to the Contiguous US, Alaska, and Hawaii. There are no other warranties, expressed or implied, other than those specifically described here.

### Warranty Periods

#### FIVE (5) YEAR WARRANTY COVERAGE

Amalfi, Cortina.026, Eclipse Wired, Moon Tables, Sierra.015, Splash Air & Tahoe.h24: covered for use within 75 miles of salt water and in full sunlight).

Via Seating reserves the right to make changes in design/construction and to discontinue products without prior notice.

## Warranty (pg 2 of 2)

### Warranty Exceptions

(ie. not covered under warranty)

- Graded-In, COM/COL textiles.
- Color-fastness or matching of colors patterns or dye lot, including; minor variations, color matches to swatches used for specification purposes and/or prior purchases.
- Products specified outside of those shown in the Via Seating price list.
- Products with unauthorized repair or alteration.
- Products not used, maintained or installed in accordance with Via Seating's applicable guidelines.
- Products exposed to conditions deemed extreme (i.e. environments other than "normal commercial, indoor office" spaces) and damage from sunlight and UV rays.
- Products purchased "as is" or second hand/refurbished products.
- Products sold by unauthorized dealers.
- Variations of leather; dye lots, environment marks, scars, bites, rubs, wrinkles, stretch marks, pattern markings and minor irregularities in color, surface, grain & texture.
- Samples, floor/showroom samples, road samples.
- Damage caused by the carrier in-transit, which will be handled as a separate claim against the carrier.
- Damage caused by staining, sharp objects, imprinting from instruments and water damage.

### Claim Process

In order to process your warranty claim accurately and efficiently please enter your warranty claim through our website at: <https://viaseating.com/warranty/>

### Changes to This Policy

We may revise and update this policy from time to time at our sole discretion. All changes are effective immediately when we post them. If changes are material to this policy, we will make every effort to notify you before these amendments enter into force. Your continued use of the Via Seating Services means you accept and agree to any modifications to this policy.

### Contact Us

For any questions, please contact us at <https://viaseating.com/contact-us/>

Direct URL: [www.viaseating.com/warranty](http://www.viaseating.com/warranty)





## Installation Guidelines

### Fixing & Safety

#### Is material for the installation supplied?

No, any fixing to the ground is the installer's responsibility.

### Structural Tests

The seats have passed the structural tests designed for the benches with ground fixing (table 2 of the UNI 11306:2009 standard and table 1 of the EN 12727:2000 standard, 4th level). Tests available upon request.

#### Can the benches be installed in environments with extreme hot or cold temperatures?

Yes, the products have passed the heat and humidity cycle tests in the 'PTP 45' climatic chamber. You can request the test from Via Seating.

### Benches Not Fixed to the Ground

Structural tests have assumed products will be fixed to the ground to ensure safety in all environments. The use of the products without fixing them to a solid ground surface remains at the discretion and responsibility of the client.

### Products Requiring Assembly

See website or QR code next to each applicable model within this price book for detailed assembly directions on products requiring some assembly.

### Ground Installation

It is the responsibility of the qualified installer to verify the particularities of the pavement and to choose the most suitable fixing methods. Via Inc. suggests the following procedure as an installation example only and declines any liability in case of damage to the products or to any underground utilities.

1. When you receive the goods and remove the packaging, taking care not to damage the finishes.
2. Place the product in the desired position and mark the positions of the holes.
3. Move the element and drill the pavement in the marked positions.
4. We recommend the use of wall plugs for M8 screws in case of installation on a hard surface.
5. In the absence of pavement, we recommend the construction of plinths provided with M8 anchor bolts.
6. Use stainless wall plugs if the bench is installed outdoors.
7. Proceed with tightening the screws.

### Connection of Seating Product Not Fixed to the Pavement

For use in non-urban environments, linking plates are available to join the benches without fixing them to the ground. However, this type of installation is only recommended for select models connected by collection specific brackets. See options by applicable product in the pricing pages above.

## Contacts & Useful Links

Outdoor Product Expert: Nora Fenlon, CCO, [nora@viaseating.com](mailto:nora@viaseating.com)

Find Your Rep: <https://viaseating.com/representatives/>

Explore Outdoor: <https://viaseating.com/outdoor/>

Contact Us: <https://viaseating.com/contact-us>





# URBANTIME<sup>®</sup>

DIEMMEBI

Visit [ViaSeating.com](https://ViaSeating.com) or call us at 800-433-6614.



[pinterest.com/viaseating](https://pinterest.com/viaseating)



[instagram.com/via\\_seating](https://instagram.com/via_seating)



[www.youtube.com/@via\\_seating](https://www.youtube.com/@via_seating)

© Via Seating 2024. All rights reserved. Product specifications are subject to change without notice.

