



# TAHOE.h24

Cubes

DESIGN Basaglia & Rota Nodari





The Tahoe.h24 collection cubes by Italian designers Basaglia & Rota Nodari deliver a timeless, classic look enhanced by the use of 100% recyclable materials. Offered in two distinct styles: heat-transfer film wood grain effect slats & hot-dip galvanized steel metal framework or a full polyester-power coated dipped color look. Ready-equipped for fastening to the ground with bolts.

Structure: Hot-dip galvanized steel with matte polyester powder coat colors or heat transfer film faux wood effects

Manufactured in Italy / Assembly: Fully assembled / Ground Fixing: Free-standing or ground-bolted

Freight: Included in LIST Price (no additional cost) / GSA: Open Market

BASE MODEL	PART #	FINISH	LIST PRICE \$
Color cube 	● TCCUBE-1	Black - Pantone Black, RAL 9005	\$1422
	● TCCUBE-2	Anthracite - Speckled texture, RAL 7024	\$1422
	○ TCCUBE-3	White - Pantone 705, RAL 9003	\$1422
	● TCCUBE-18	Corten - Speckled texture	\$1422
	● TCCUBE-9	Sand - Pantone Warm Grey 5 C, RAL 7032	\$1422
	● TCCUBE-4	Red - Pantone 187, RAL 3000	\$1422
Max Weight: 2500 lb			
Faux wood cube 	● TNCUBE-2-N	Anthracite framework with faux ash wood	\$1576
	● TNCUBE-2-NDO	Anthracite framework with faux dark oak wood	\$1576
	○ TNCUBE-3-N	White framework with faux ash wood	\$1576
	○ TNCUBE-3-NDO	White framework with faux dark oak wood	\$1576
	● TNCUBE-18-N	Corten framework with faux ash wood	\$1576
	● TNCUBE-18-NDO	Corten framework with faux dark oak wood	\$1576
Max Weight: 2500 lb			

## Additional Options

N/A

## Product Assembly

<i>OPTION</i>	<i>PART #</i>	<i>DESCRIPTION</i>	<i>LIST PRICE \$</i>
Fully Assembled	-FA	Models arrive fully assembled.	\$0

## Dimensions

The below dimensions were recorded by the URBANTIME® team using centimeters (cm) for distances & kilograms (kg) for product weight as the unit of measurement. Note, packaging not included.

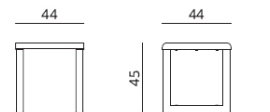

Cube chair

13,8 kg \*

# TAHOE.h24



Flat benches

DESIGN Basaglia & Rota Nodari



The Tahoe.h24 collection flat benches by Italian designers Basaglia & Rota Nodari deliver a timeless, classic look enhanced by the use of 100% recyclable materials. Available armless or with arms. Offered in two distinct styles: heat-transfer film wood grain effect slats & hot-dip galvanized steel metal framework or a full polyester-power coated dipped color look. Ready-equipped for fastening to the ground with bolts.

Structure: Hot-dip galvanized steel with matte polyester powder coat colors or heat transfer film faux wood effects  
 Manufactured in Italy / Assembly: Some assembly required / Ground Fixing: Free-standing or ground-bolted  
**Freight: Included in LIST Price (no additional cost) / GSA: Open Market**

BASE MODEL	PART #	FINISH	LIST PRICE \$
Color flat bench  Max Weight: 2500 lb	● TFC15-1	Black - Pantone Black, RAL 9005	\$2829
	● TFC15-2	Anthracite - Speckled texture, RAL 7024	\$2829
	○ TFC15-3	White - Pantone 705, RAL 9003	\$2829
	● TFC15-18	Corten - Speckled texture	\$2829
	● TFC15-9	Sand - Pantone Warm Grey 5 C, RAL 7032	\$2829
	● TFC15-4	Red - Pantone 187, RAL 3000	\$2829
Faux wood flat bench  Max Weight: 2500 lb	● TFN15-2-N	Anthracite framework with faux ash wood	\$3160
	● TFN15-2-NDO	Anthracite framework with faux dark oak wood	\$3160
	○ TFN15-3-N	White framework with faux ash wood	\$3160
	○ TFN15-3-NDO	White framework with faux dark oak wood	\$3160
	● TFN15-18-N	Corten framework with faux ash wood	\$3160
	● TFN15-18-NDO	Corten framework with faux dark oak wood	\$3160

## Additional Options

OPTION	PART #	DESCRIPTION	LIST PRICE \$
Fixed arm	-AFB	Arm for the left side, right side or middle location on the flat bench.	\$340

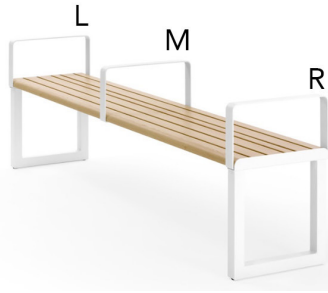

**EXAMPLE:**  
TFN15-3-N-AFB-3-AFB-3-AFB-3

## Product Assembly

OPTION	PART #	DESCRIPTION	LIST PRICE \$
Assembly Required	-AR	Models arrive requiring some assembly.	\$0

## Dimensions

The below dimensions were recorded by the URBANTIME® team using centimeters (cm) for distances & kilograms (kg) for product weight as the unit of measurement. Note, packaging not included.

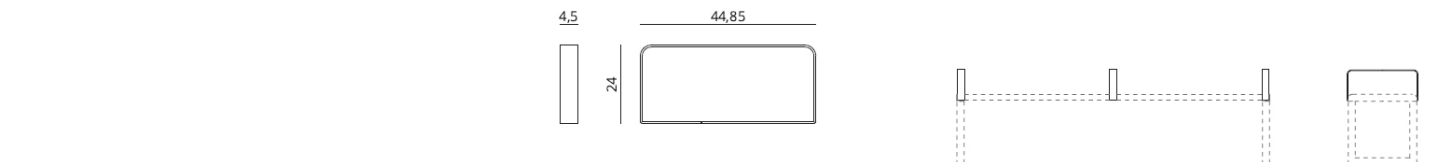

# TAHOE.h24















Benches with backrests

DESIGN Basaglia & Rota Nodari



The Tahoe.h24 collection benches with backrests by Italian designers Basaglia & Rota Nodari deliver a timeless, classic look enhanced by the use of 100% recyclable materials. Available armless or with arms. Offered in two distinct styles: heat-transfer film wood grain effect slats & hot-dip galvanized steel metal framework or a full polyester-power coated dipped color look. Ready-equipped for fastening to the ground with bolts.

Structure: Hot-dip galvanized steel with matte polyester powder coat colors or heat transfer film faux wood effects  
 Manufactured in Italy / Assembly: Some assembly required / Ground Fixing: Free-standing or ground-bolted  
**Freight: Included in LIST Price (no additional cost)** / GSA: Open Market

BASE MODEL		PART #	FINISH	LIST PRICE \$
 Color bench with backrest Max Weight: 2500 lb		TBC20-1	Black - Pantone Black, RAL 9005	\$3812
		TBC20-2	Anthracite - Speckled texture, RAL 7024	\$3812
		TBC20-3	White - Pantone 705, RAL 9003	\$3812
		TBC20-18	Corten - Speckled texture	\$3812
		TBC20-9	Sand - Pantone Warm Grey 5 C, RAL 7032	\$3812
		TBC20-4	Red - Pantone 187, RAL 3000	\$3812
 Faux wood bench with backrest Max Weight: 2500 lb		TBN20-2-N	Anthracite framework with faux ash wood	\$4573
		TBN20-2-NDO	Anthracite framework with faux dark oak wood	\$4573
		TBN20-3-N	White framework with faux ash wood	\$4573
		TBN20-3-NDO	White framework with faux dark oak wood	\$4573
		TBN20-18-N	Corten framework with faux ash wood	\$4573
		TBN20-18-NDO	Corten framework with faux dark oak wood	\$4573

## Additional Options

OPTION	PART #	DESCRIPTION	LIST PRICE \$
Fixed arm	-ABB	Arm for either side of the bench with backrest.	\$340

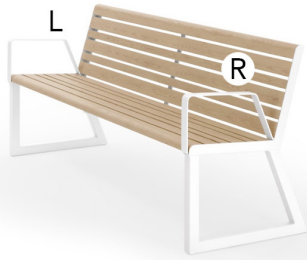

**EXAMPLE:**  
TBN20-3-N-ABB-3-ABB-3

## Product Assembly

OPTION	PART #	DESCRIPTION	LIST PRICE \$
Assembly Required	-AR	Models arrive requiring some assembly.	\$0

## Dimensions

The below dimensions were recorded by the URBANTIME® team using centimeters (cm) for distances & kilograms (kg) for product weight as the unit of measurement. Note, packaging not included.

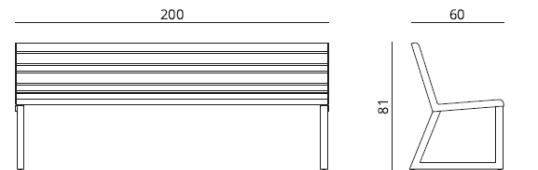

Bench with backrest

49 kg \*

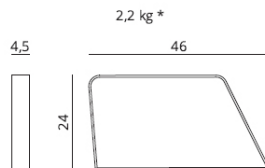

2,2 kg \*

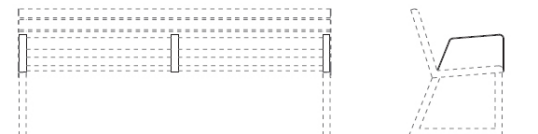

Optional armrest for bench with backrest

# TAHOE.h24





















Double seat benches

DESIGN Basaglia & Rota Nodari



The Tahoe.h24 collection double seat benches by Italian designers Basaglia & Rota Nodari deliver a timeless, classic look enhanced by the use of 100% recyclable materials. Offered in two distinct styles: heat-transfer film wood grain effect slats & hot-dip galvanized steel metal framework or a full polyester-power coated dipped color look. Ready-equipped for fastening to the ground with bolts.

Structure: Hot-dip galvanized steel with matte polyester powder coat colors or heat transfer film faux wood effects  
 Manufactured in Italy / Assembly: Some assembly required / Ground Fixing: Free-standing or ground-bolted  
**Freight: Included in LIST Price (no additional cost) / GSA: Open Market**

BASE MODEL	PART #	FINISH	LIST PRICE \$
Color double seat bench 	 TBC15-1	Black - Pantone Black, RAL 9005	\$4594
	 TBC15-2	Anthracite - Speckled texture, RAL 7024	\$4594
	 TBC15-3	White - Pantone 705, RAL 9003	\$4594
	 TBC15-18	Corten - Speckled texture	\$4594
	 TBC15-9	Sand - Pantone Warm Grey 5 C, RAL 7032	\$4594
Max Weight: 2500 lb	 TBC15-4	Red - Pantone 187, RAL 3000	\$4594
Faux wood double seat bench 	  TBN15-2-N	Anthracite framework with faux ash wood	\$5662
	  TBN15-2-NDO	Anthracite framework with faux dark oak wood	\$5662
	  TBN15-3-N	White framework with faux ash wood	\$5662
	  TBN15-3-NDO	White framework with faux dark oak wood	\$5662
	  TBN15-18-N	Corten framework with faux ash wood	\$5662
	  TBN15-18-NDO	Corten framework with faux dark oak wood	\$5662
Max Weight: 2500 lb			



## Additional Options

OPTION	PART #	DESCRIPTION	LIST PRICE \$
Fixed arm	-ABB	Arm for either side of the double seat bench.	\$340

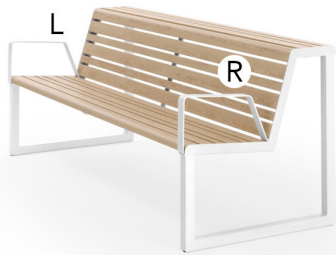

**EXAMPLE:**  
TBN15-3-N-ABB-3-ABB-3

## Product Assembly

OPTION	PART #	DESCRIPTION	LIST PRICE \$
Assembly Required	-AR	Models arrive requiring some assembly.	\$0

## Dimensions

The below dimensions were recorded by the URBANTIME® team using centimeters (cm) for distances & kilograms (kg) for product weight as the unit of measurement. Note, packaging not included.

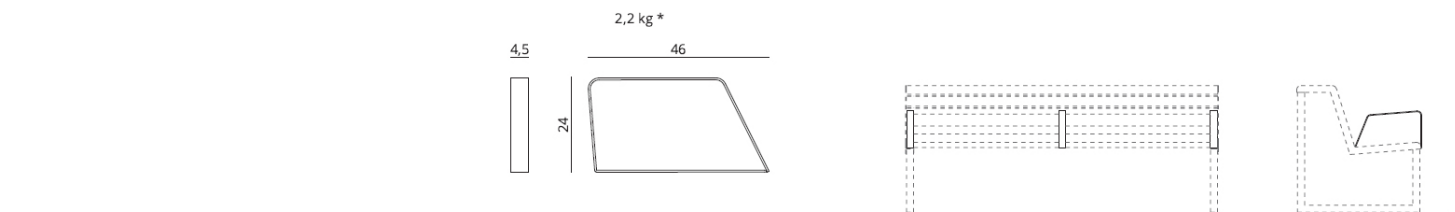

Optional armrest for double seat bench

# TAHOE.h24



Tables

DESIGN Basaglia & Rota Nodari



The Tahoe.h24 collection tables by Italian designers Basaglia & Rota Nodari deliver a timeless, classic look enhanced by the use of 100% recyclable materials. Available with optional umbrella hole or sun shade. Table offered in two distinct styles: heat-transfer film wood grain effect slats & hot-dip galvanized steel metal framework or a full polyester-power coated dipped color look. Ready-equipped for fastening to the ground with bolts.

Structure: Hot-dip galvanized steel with matte polyester powder coat colors or heat transfer film faux wood effects  
 Manufactured in Italy / Assembly: Some assembly required / Ground Fixing: Free-standing or ground-bolted  
**Freight: Included in LIST Price (no additional cost)** / GSA: Open Market

BASE MODEL	PART #	FINISH	LIST PRICE \$
Color table 	● TTC25-1	Black - Pantone Black, RAL 9005	\$3975
	● TTC25-2	Anthracite - Speckled texture, RAL 7024	\$3975
	○ TTC25-3	White - Pantone 705, RAL 9003	\$3975
	● TTC25-18	Corten - Speckled texture	\$3975
	● TTC25-9	Sand - Pantone Warm Grey 5 C, RAL 7032	\$3975
	● TTC25-4	Red - Pantone 187, RAL 3000	\$3975
Max Weight: 2500 lb			
Faux wood table 	● TTN25-2-N	Anthracite framework with faux ash wood	\$4791
	● TTN25-2-NDO	Anthracite framework with faux dark oak wood	\$4791
	○ TTN25-3-N	White framework with faux ash wood	\$4791
	○ TTN25-3-NDO	White framework with faux dark oak wood	\$4791
	● TTN25-18-N	Corten framework with faux ash wood	\$4791
	● TTN25-18-NDO	Corten framework with faux dark oak wood	\$4791
Max Weight: 2500 lb			

## Additional Options

### Umbrella Hole

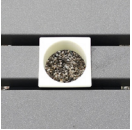
<i>OPTION</i>	<i>PART #</i>	<i>DESCRIPTION</i>	<i>LIST PRICE \$</i>
	H1	Center hole with a 2.2" x 2.2" round insert for placing an umbrella pole.	\$286

## Product Assembly

<i>OPTION</i>	<i>PART #</i>	<i>DESCRIPTION</i>	<i>LIST PRICE \$</i>
Assembly Required	-AR	Models arrive requiring some assembly.	\$0

## Dimensions

The below dimensions were recorded by the URBANTIME® team using centimeters (cm) for distances & kilograms (kg) for product weight as the unit of measurement. Note, packaging not included.



Table

50 kg \*

## TAHOE.h24

Tables + Integrated Benches

DESIGN Basaglia &amp; Rota Nodari



The Tahoe.h24 collection tables by Italian designers Basaglia & Rota Nodari deliver a timeless, classic look enhanced by the use of 100% recyclable materials. Available with optional umbrella hole or sun shade. Table offered in two distinct styles: heat-transfer film wood grain effect slats & hot-dip galvanized steel metal framework or a full polyester-power coated dipped color look. Ready-equipped for fastening to the ground with bolts.

Structure: Hot-dip galvanized steel with matte polyester powder coat colors or heat transfer film faux wood effects

Manufactured in Italy / Assembly: Some assembly required / Ground Fixing: Free-standing or ground-bolted

**Freight: Included in LIST Price (no additional cost)** / GSA: Open Market

BASE MODEL	PART #	FINISH	LIST PRICE \$
Linking plate for connecting a flat backless bench to a table	● DLF15-1	Black - Pantone Black, RAL 9005	\$769
	● DLF15-2	Anthracite - Speckled texture, RAL 7024	\$769
	○ DLF15-3	White - Pantone 705, RAL 9003	\$769
	● DLF15-18	Corten - Speckled texture	\$769
	● DLF15-9	Sand - Pantone Warm Grey 5 C, RAL 7032	\$769
Note: Price 1 per side	● DLF15-4	Red - Pantone 187, RAL 3000	\$769
Linking plate for connecting a bench with a backrest to a table	● DL20-1	Black - Pantone Black, RAL 9005	\$840
	● DL20-2	Anthracite - Speckled texture, RAL 7024	\$840
	○ DL20-3	White - Pantone 705, RAL 9003	\$840
	● DL20-18	Corten - Speckled texture	\$840
	● DL20-9	Sand - Pantone Warm Grey 5 C, RAL 7032	\$840
Note: Price 1 per side	● DL20-4	Red - Pantone 187, RAL 3000	\$840
Linking plate for connecting a double seat bench to a table	● DL15-1	Black - Pantone Black, RAL 9005	\$882
	● DL15-2	Anthracite - Speckled texture, RAL 7024	\$882
	○ DL15-3	White - Pantone 705, RAL 9003	\$882
	● DL15-18	Corten - Speckled texture	\$882
	● DL15-9	Sand - Pantone Warm Grey 5 C, RAL 7032	\$882
Note: Price 1 per side	● DL15-4	Red - Pantone 187, RAL 3000	\$882

## Example



**< EXAMPLE MODELS:**

- TTN25-3-N (x1) - table
- TBN15-3-N (x2) - double seat benches
- DL15-3 (x2) - brackets

## Product Assembly

OPTION	PART #	DESCRIPTION	LIST PRICE \$
Assembly Required	-AR	Models arrive requiring some assembly.	\$0

## Dimensions

The below dimensions were recorded by the URBANTIME® team using centimeters (cm) for distances & kilograms (kg) for product weight as the unit of measurement. Note, packaging not included.

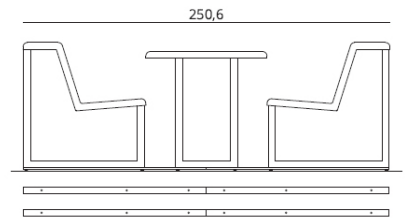
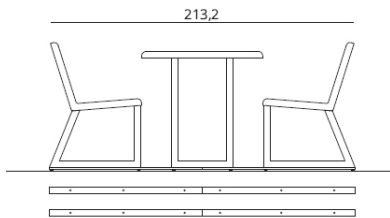
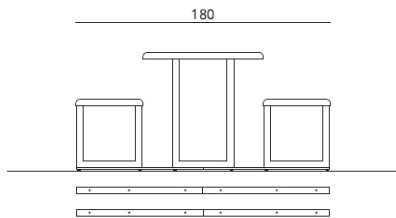

Same benches on either side of table

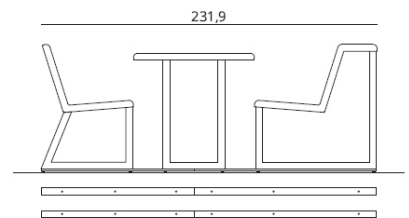
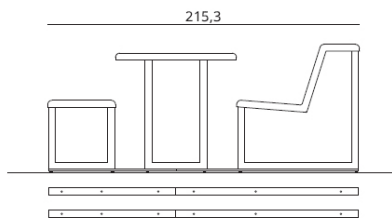
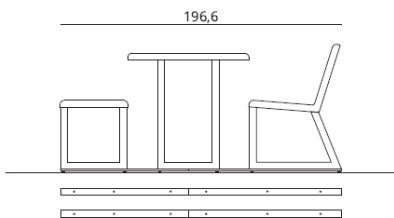

Different benches on either side of table

# TAHOE.h24



## Picnic Tables

DESIGN Basaglia & Rota Nodari



The Tahoe.h24 collection picnic tables by Italian designers Basaglia & Rota Nodari deliver a timeless, classic look enhanced by the use of 100% recyclable materials. Optional umbrella hole or sun shade. Offered in two distinct styles: heat-transfer film wood grain effect slats & hot-dip galvanized steel metal framework or a full polyester-power coated dipped color look. Ready-equipped for fastening to the ground with bolts.

Structure: Hot-dip galvanized steel with matte polyester powder coat colors or heat transfer film faux wood effects  
 Manufactured in Italy / Assembly: Some assembly required / Ground Fixing: Free-standing or ground-bolted  
**Freight: Included in LIST Price (no additional cost)** / GSA: Open Market

BASE MODEL	PART #	FINISH	LIST PRICE \$
Color picnic table  Max Weight: 2500 lb	● TPC15-1	Black - Pantone Black, RAL 9005	\$7045
	● TPC15-2	Anthracite - Speckled texture, RAL 7024	\$7045
	○ TPC15-3	White - Pantone 705, RAL 9003	\$7045
	● TPC15-18	Corten - Speckled texture	\$7045
	● TPC15-9	Sand - Pantone Warm Grey 5 C, RAL 7032	\$7045
	● TPC15-4	Red - Pantone 187, RAL 3000	\$7045
Faux wood picnic table  Max Weight: 2500 lb	● TPN15-2-N	Anthracite framework with faux ash wood	\$8540
	● TPN15-2-NDO	Anthracite framework with faux dark oak wood	\$8540
	○ TPN15-3-N	White framework with faux ash wood	\$8540
	○ TPN15-3-NDO	White framework with faux dark oak wood	\$8540
	● TPN15-18-N	Corten framework with faux ash wood	\$8540
	● TPN15-18-NDO	Corten framework with faux dark oak wood	\$8540

## Additional Options

### Umbrella Hole

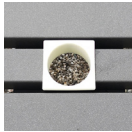
OPTION	PART #	DESCRIPTION	LIST PRICE \$
	H1	Center hole with a 2.2" x 2.2" round insert for placing an umbrella pole.	\$286

## Product Assembly

OPTION	PART #	DESCRIPTION	LIST PRICE \$
Assembly Required	-AR	Models arrive requiring some assembly.	\$0

## Dimensions

The below dimensions were recorded by the URBANTIME® team using centimeters (cm) for distances & kilograms (kg) for product weight as the unit of measurement. Note, packaging not included.

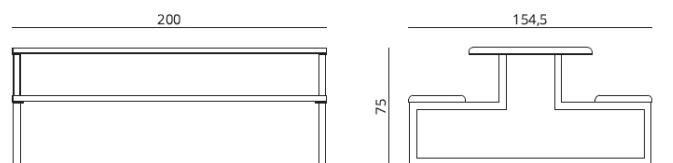

Picnic table

65 kg \*

# TAHOE.h24

"Miami" Sun Shade

DESIGN Basaglia & Rota Nodari



The Tahoe.h24 collection "Miami" sun shade by Italian designers Basaglia & Rota Nodari works on the table & picnic table models. It is composed of a sturdy, linear steel structure and a minimal design, carrying a large rectangular sheet. The cover, thanks to special brackets, can be anchored to all the tables of the Tahoe.h24 collection. The high-tech fabric is fireproof and has the ability to block 98% of harmful UV rays.

Structure: Framework treated with cathaphoresis & painted with matte polyester powder coat + canvas sun shade  
 Manufactured in Italy / Assembly: Some assembly required / Ground Fixing: Joined to table

**Freight: Included in LIST Price (no additional cost) / GSA: Open Market**



BASE MODEL	PART #	FINISH	LIST PRICE \$
	● DSS1-1	Black - Pantone Black, RAL 9005	\$3517
	● DSS1-2	Anthracite - Speckled texture, RAL 7024	\$3517
	○ DSS1-3	White - Pantone 705, RAL 9003	\$3517
	● DSS1-18	Corten - Speckled texture	\$3517
	● DSS1-9	Sand - Pantone Warm Grey 5 C, RAL 7032	\$3517
	● DSS1-4	Red - Pantone 187, RAL 3000	\$3517



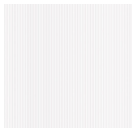

## Additional Options

### Sun Shade Colors

OPTION	PART #	DESCRIPTION	LIST PRICE \$
	DC1	Miami Sun Shade: White UV stabilized HDPE mesh, 100% polyethylene sun shade. Metal framework for shade included in price.	\$0
	DC2	Miami Sun Shade: Anthracite UV stabilized HDPE mesh, 100% polyethylene sun shade. Metal framework for shade included in price.	\$0

## Product Assembly

OPTION	PART #	DESCRIPTION	LIST PRICE \$
Assembly Required	-AR	Models arrive requiring some assembly.	\$0

## Dimensions

The below dimensions were recorded by the URBANTIME® team using centimeters (cm) for distances & kilograms (kg) for product weight as the unit of measurement. Note, packaging not included.

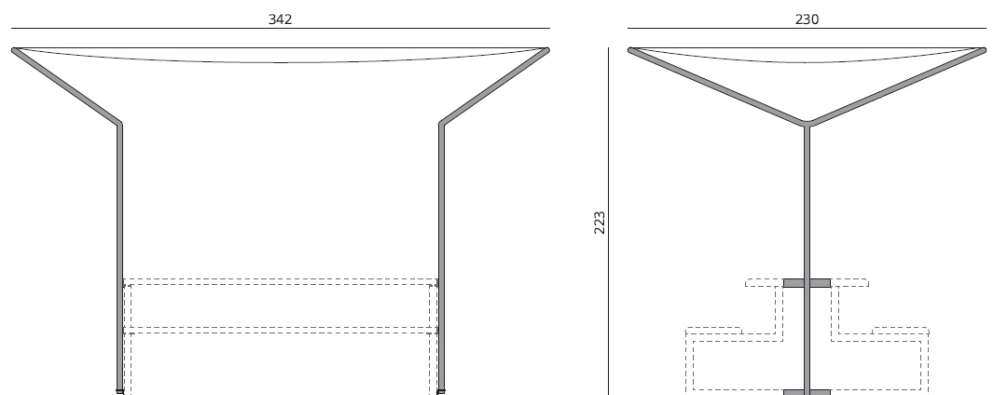

"Miami" Sun Shade

9,3 kg \*

# TAHOE.h24





















## Chaise Lounges

DESIGN Basaglia & Rota Nodari





The Tahoe.h24 collection chaise lounge by Italian designers Basaglia & Rota Nodari deliver a timeless, classic look enhanced by the use of 100% recyclable materials. Available with an optional pillow to enhance the comfort. Offered in two distinct styles: heat-transfer film wood grain effect slats & hot-dip galvanized steel metal framework or a full polyester-power coated dipped color look. Ready-equipped for ground bolting.

Structure: Hot-dip galvanized steel with matte polyester powder coat colors or heat transfer film faux wood effects  
 Manufactured in Italy / Assembly: Some assembly required / Ground Fixing: Free-standing or ground-bolted  
**Freight: Included in LIST Price (no additional cost)** / GSA: Open Market

BASE MODEL	PART #	FINISH	LIST PRICE \$
Color chaise lounge 	 TCH15-1	Black - Pantone Black, RAL 9005	\$5604
	 TCH15-2	Anthracite - Speckled texture, RAL 7024	\$5604
	 TCH15-3	White - Pantone 705, RAL 9003	\$5604
	 TCH15-18	Corten - Speckled texture	\$5604
	 TCH15-9	Sand - Pantone Warm Grey 5 C, RAL 7032	\$5604
	 TCH15-4	Red - Pantone 187, RAL 3000	\$5604
Faux wood chaise lounge 	  TCN15-2-N	Anthracite framework with faux ash wood	\$6191
	  TCN15-2-NDO	Anthracite framework with faux dark oak wood	\$6191
	  TCN15-3-N	White framework with faux ash wood	\$6191
	  TCN15-3-NDO	White framework with faux dark oak wood	\$6191
	  TCN15-18-N	Corten framework with faux ash wood	\$6191
	  TCN15-18-NDO	Corten framework with faux dark oak wood	\$6191

## Additional Options

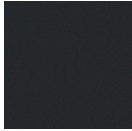
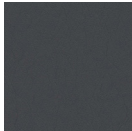
### Optional Upholstered Pillow

OPTION	PART #	DESCRIPTION	LIST PRICE \$
	P1	Black vinyl pillow for outdoor use.	\$0
	P2	Grey vinyl pillow for outdoor use.	\$0
	P3	White vinyl pillow for outdoor use.	\$0
	P4	Red vinyl pillow for outdoor use.	\$0

## Product Assembly

OPTION	PART #	DESCRIPTION	LIST PRICE \$
Assembly Required	-AR	Models arrive requiring some assembly.	\$0

## Dimensions

The below dimensions were recorded by the URBANTIME® team using centimeters (cm) for distances & kilograms (kg) for product weight as the unit of measurement. Note, packaging not included.

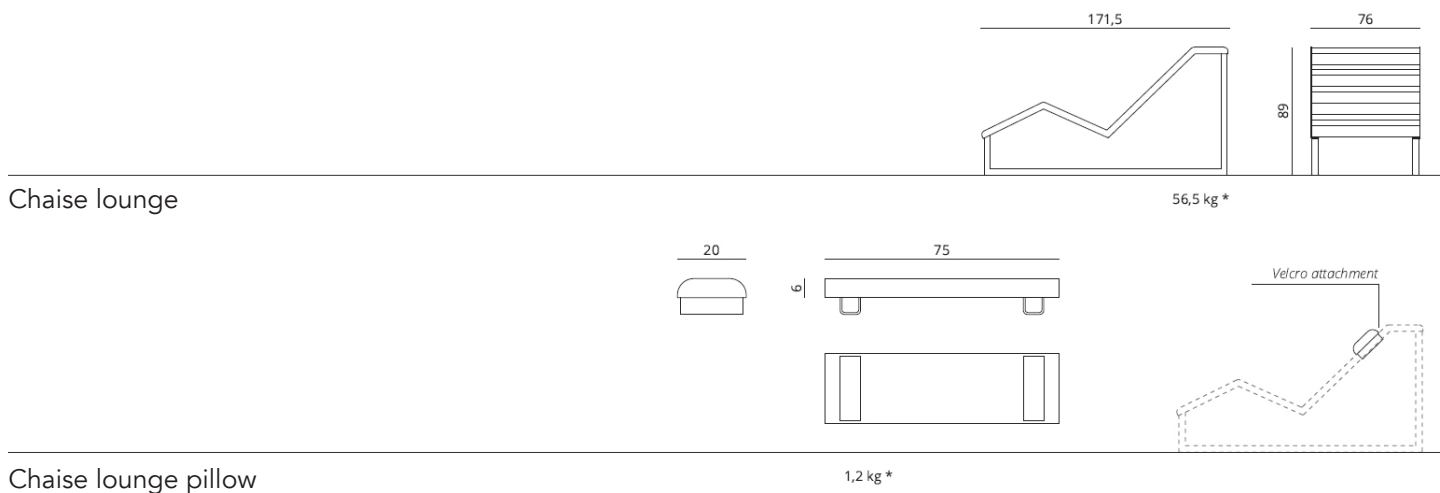

# TAHOE.h24











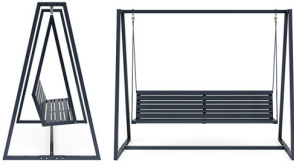









Swings

DESIGN Basaglia & Rota Nodari



The Tahoe.h24 collection swings by Italian designers Basaglia & Rota Nodari deliver a timeless, classic look enhanced by the use of 100% recyclable materials. Offered in two distinct styles: heat-transfer film wood grain effect slats & hot-dip galvanized steel metal framework or a full polyester-power coated dipped color look. Ready-equipped for fastening to the ground with bolts.

Structure: Hot-dip galvanized steel with matte polyester powder coat colors or heat transfer film faux wood effects  
 Manufactured in Italy / Assembly: Some assembly required / Ground Fixing: Free-standing or ground-bolted  
**Freight: Included in LIST Price (no additional cost)** / GSA: Open Market

BASE MODEL	PART #	FINISH	LIST PRICE \$
Color swing 	 TSC20-1	Black - Pantone Black, RAL 9005	\$10896
	 TSC20-2	Anthracite - Speckled texture, RAL 7024	\$10896
	 TSC20-3	White - Pantone 705, RAL 9003	\$10896
	 TSC20-18	Corten - Speckled texture	\$10896
	 TSC20-9	Sand - Pantone Warm Grey 5 C, RAL 7032	\$10896
	 TSC20-4	Red - Pantone 187, RAL 3000	\$10896
Max Weight: 2500 lb			
Faux wood swing 	  TSN20-2-N	Anthracite framework with faux ash wood	\$12060
	  TSN20-2-NDO	Anthracite framework with faux dark oak wood	\$12060
	  TSN20-3-N	White framework with faux ash wood	\$12060
	  TSN20-3-NDO	White framework with faux dark oak wood	\$12060
	  TSN20-18-N	Corten framework with faux ash wood	\$12060
	  TSN20-18-NDO	Corten framework with faux dark oak wood	\$12060
Max Weight: 2500 lb			

## Additional Options

N/A

## Product Assembly

<i>OPTION</i>	<i>PART #</i>	<i>DESCRIPTION</i>	<i>LIST PRICE \$</i>
Assembly Required	-AR	Models arrive requiring some assembly.	\$0

## Dimensions

The below dimensions were recorded by the URBANTIME® team using centimeters (cm) for distances & kilograms (kg) for product weight as the unit of measurement. Note, packaging not included.

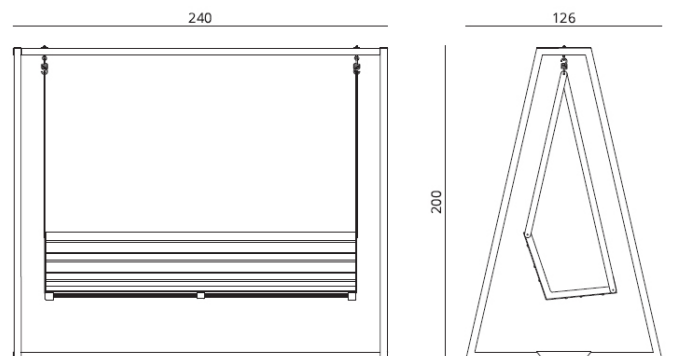

Swing

100 kg \*

# TAHOE.h24

Planters

DESIGN Basaglia & Rota Nodari





The Tahoe.h24 collection planters by Italian designers Basaglia & Rota Nodari deliver a timeless, classic look enhanced by the use of 100% recyclable materials. Offered in two distinct styles: heat-transfer film wood grain effect slats & hot-dip galvanized steel metal framework or a full polyester-power coated dipped color look. Ready-equipped for fastening to the ground with bolts.

Structure: Hot-dip galvanized steel with matte polyester powder coat colors or heat transfer film faux wood effects

Manufactured in Italy / Assembly: Fully assembled / Ground Fixing: Free-standing or ground-bolted

Freight: Included in LIST Price (no additional cost) / GSA: Open Market

BASE MODEL	PART #	FINISH	LIST PRICE \$
 Color planter	● TGC15-1	Black - Pantone Black, RAL 9005	\$2242
	● TGC15-2	Anthracite - Speckled texture, RAL 7024	\$2242
	○ TGC15-3	White - Pantone 705, RAL 9003	\$2242
	● TGC15-18	Corten - Speckled texture	\$2242
	● TGC15-9	Sand - Pantone Warm Grey 5 C, RAL 7032	\$2242
	● TGC15-4	Red - Pantone 187, RAL 3000	\$2242
 Faux wood planter	● TGN15-2-N	Anthracite framework with faux ash wood	\$2776
	● TGN15-2-NDO	Anthracite framework with faux dark oak wood	\$2776
	○ TGN15-3-N	White framework with faux ash wood	\$2776
	○ TGN15-3-NDO	White framework with faux dark oak wood	\$2776
	● TGN15-18-N	Corten framework with faux ash wood	\$2776
	● TGN15-18-NDO	Corten framework with faux dark oak wood	\$2776

## Additional Options

N/A

## Product Assembly

OPTION	PART #	DESCRIPTION	LIST PRICE \$
Fully Assembled	-FA	Models arrive fully assembled.	\$0

## Dimensions

The below dimensions were recorded by the URBANTIME® team using centimeters (cm) for distances & kilograms (kg) for product weight as the unit of measurement. Note, packaging not included.

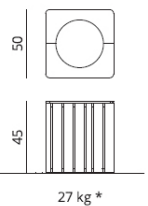

Planter

# TAHOE.h24



## Big Litter Bins

DESIGN Basaglia & Rota Nodari



The Tahoe.h24 collection open-top litter bins by Italian designers Basaglia & Rota Nodari deliver a timeless, classic look enhanced by the use of 100% recyclable materials. Offered in two distinct styles: heat-transfer film wood grain effect slats & hot-dip galvanized steel metal framework or a full polyester-power coated dipped color look. Ready-equipped for fastening to the ground with bolts.

Structure: Hot-dip galvanized steel with matte polyester powder coat colors or heat transfer film faux wood effects  
 Manufactured in Italy / Assembly: Some assembly required / Ground Fixing: Free-standing or ground-bolted  
**Freight: Included in LIST Price (no additional cost)** / GSA: Open Market

BASE MODEL	PART #	FINISH	LIST PRICE \$
Color litter bin  Bin Capacity: 17 gallon	● TLC15-1	Black - Pantone Black, RAL 9005	\$3951
	● TLC15-2	Anthracite - Speckled texture, RAL 7024	\$3951
	○ TLC15-3	White - Pantone 705, RAL 9003	\$3951
	● TLC15-18	Corten - Speckled texture	\$3951
	● TLC15-9	Sand - Pantone Warm Grey 5 C, RAL 7032	\$3951
	● TLC15-4	Red - Pantone 187, RAL 3000	\$3951
Faux wood litter bin  Bin Capacity: 17 gallon	● TLN15-2-N	Anthracite framework with faux ash wood	\$4483
	● TLN15-2-NDO	Anthracite framework with faux dark oak wood	\$4483
	○ TLN15-3-N	White framework with faux ash wood	\$4483
	○ TLN15-3-NDO	White framework with faux dark oak wood	\$4483
	● TLN15-18-N	Corten framework with faux ash wood	\$4483
	● TLN15-18-NDO	Corten framework with faux dark oak wood	\$4483



## Additional Options

N/A

## Product Assembly

<i>OPTION</i>	<i>PART #</i>	<i>DESCRIPTION</i>	<i>LIST PRICE \$</i>
Assembly Required	-AR	Models arrive requiring some assembly.	\$0

## Dimensions

The below dimensions were recorded by the URBANTIME® team using centimeters (cm) for distances & kilograms (kg) for product weight as the unit of measurement. Note, packaging not included.

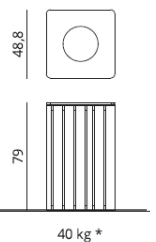

Litter Bins

# TAHOE.h24

Big Litter Bins with Lids

DESIGN Basaglia & Rota Nodari





The Tahoe.h24 collection open-top litter bins with lids by Italian designers Basaglia & Rota Nodari deliver a timeless, classic look enhanced by the use of 100% recyclable materials. Offered in two distinct styles: heat-transfer film wood grain effect slats & hot-dip galvanized steel metal framework or a full polyester-power coated dipped color look. Ready-equipped for fastening to the ground with bolts.

Structure: Hot-dip galvanized steel with matte polyester powder coat colors or heat transfer film faux wood effects

Manufactured in Italy / Assembly: Fully assembled / Ground Fixing: Free-standing or ground-bolted

Freight: Included in LIST Price (no additional cost) / GSA: Open Market

BASE MODEL	PART #	FINISH	LIST PRICE \$
 Color litter bin with lid Bin Capacity: 17 gallon	● TLC20-1	Black - Pantone Black, RAL 9005	\$4335
	● TLC20-2	Anthracite - Speckled texture, RAL 7024	\$4335
	○ TLC20-3	White - Pantone 705, RAL 9003	\$4335
	● TLC20-18	Corten - Speckled texture	\$4335
	● TLC20-9	Sand - Pantone Warm Grey 5 C, RAL 7032	\$4335
	● TLC20-4	Red - Pantone 187, RAL 3000	\$4335
 Faux wood litter bin with lid Bin Capacity: 17 gallon	● TLN20-2-N	Anthracite framework with faux ash wood	\$4869
	● TLN20-2-NDO	Anthracite framework with faux dark oak wood	\$4869
	○ TLN20-3-N	White framework with faux ash wood	\$4869
	○ TLN20-3-NDO	White framework with faux dark oak wood	\$4869
	● TLN20-18-N	Corten framework with faux ash wood	\$4869
	● TLN20-18-NDO	Corten framework with faux dark oak wood	\$4869

## Additional Options

### Litter Bin Labels and/or Ashtrays

OPTION	PART #	DESCRIPTION	LIST PRICE \$
	● DL01	Stainless steel "Plastic" lid label.	\$0
	● DL02	Stainless steel "Waste" lid label.	\$0
	● DL03	Stainless steel "Aluminum" lid label.	\$0
	● DL04	Stainless steel "Paper" lid label.	\$0
	● DL05	Stainless steel "Organic Matter" lid label.	\$0
	● DLA1	Stainless steel "Plastic" lid label with ashtray.	\$135
	● DLA2	Stainless steel "Waste" lid label with ashtray.	\$135
	● DLA3	Stainless steel "Aluminum" lid label with ashtray.	\$135
	● DLA4	Stainless steel "Paper" lid label with ashtray.	\$135
	● DLA5	Stainless steel "Organic Matter" lid label with ashtray.	\$135

## Product Assembly

OPTION	PART #	DESCRIPTION	LIST PRICE \$
Fully Assembled	-FA	Models arrive fully assembled.	\$0

## Dimensions

The below dimensions were recorded by the URBANTIME® team using centimeters (cm) for distances & kilograms (kg) for product weight as the unit of measurement. Note, packaging not included.

