

Vista II

design by Studio V

Multi-use, stacking, bar stools, bariatric chairs, healthcare seating



Features

- Upholstered, mesh or poly back 4-leg chairs & stools; upholstered back bariatric chairs
- Via Seating's comfort foam: a proprietary blend of high-density, injection-molded, closed-cell, cold-cured comfort foam
- Stacking: Chairs stack 3 high on the ground, stools 2 high on the ground
- Design for the Environment (DfE): Screened to the ANSI/BIFMA e3-2019 Annex B- List of Chemicals of Concern & CA Prop 65 List
- Sustainability: BIFMA LEVEL 2 certified & CLEAN AIR GOLD certified/certified low emitting
- Specify On: Spec It, CET, GSA (contract #GS-28F-005CA), Project Matrix, 2020 ("CAP/GIZA") & KITS Collaborator

Statement of Line



Mesh chair
#312



Mesh bar stool
#313



Upholstered chair
#302



Upholstered bar stool
#303



Bariatric upholstered chair
#307



Poly poly chair
#330



Poly poly bar stool
#331



Vista II

Poly poly chair & stool #330 & #331
GSA SIN# 33721



1. Starting Model

| Part # | Price | Description |
|--------|---------------|-----------------|
| 330 | +\$389 | Poly poly chair |
| 331 | +\$457 | Poly Poly stool |



2. Frame Finish

| Part # | Price | Description |
|--------|--------------|----------------------|
| B | +\$0 | Standard matte black |
| S | +\$61 | Silver |

3. Poly Color

| Part # | Price | Description |
|--------|-------------|----------------|
| 01 | +\$0 | Standard black |

4. Arm



| Part # | Price | Description | |
|--------|--------------|----------------------------|---|
| 0A | +\$0 | Standard armless |  |
| 32A | +\$88 | Matte black fixed loop arm |  |
| 49A | +\$88 | Matte grey fixed loop arm |  |

5. Optional Casters

| Part # | Price | Description | |
|--------|---------------|--------------------------------------|---|
| WH | +\$103 | Black all floor casters ¹ |  |

Note 1: Casters only optional on chair #330.

6. Optional Ganging Brackets

| Part # | Price | Description | |
|--------|---------------|---|---|
| 33GNGR | +\$100 | Unlockable latch, permanent ganging brackets ² |  |
| 33GNGP | +\$100 | Fixed, permanent ganging brackets ² |  |

Note 2: Ganging brackets not optional with casters.

7. Optional Upholstered Seat

| Part # | Price | Description | |
|--------|-------------|------------------|---|
| 9US | +\$0 | Upholstered seat |  |

8. Packaging

| Part # | Price | Description |
|--------|----------------|---|
| FA | +\$0 | Ships fully assembled in the box |
| BW | CALL US | Ships blanket wrapped w/ minimum order quantity 150 - Call 1-800-433-6614 for pricing |

8a. Single Chair Shipment

| Part # | Price | Description |
|--------|--------------|---|
| | +\$0 | Not selected / this is a multiple chair order |
| SC | +\$74 | Single chair order ³ |

Note 3: Upcharge only applicable to a single chair #330.

Vista II

Poly poly chair & stool #330 & #331
GSA SIN# 33721



7a. #9US: Textile

| Part # | Price | Description |
|--------|--------|----------------------------------|
| GR A | +\$77 | Grade A fabric, vinyl or leather |
| GR B | +\$96 | Grade B fabric, vinyl or leather |
| GR 1 | +\$130 | Grade 1 fabric, vinyl or leather |
| COM | +\$130 | Customer's Own Fabric or Vinyl |
| GR 2 | +\$143 | Grade 2 fabric, vinyl or leather |
| GR 3 | +\$183 | Grade 3 fabric, vinyl or leather |
| COL | +\$183 | Customer's Own Leather |
| GR 4 | +\$216 | Grade 4 fabric, vinyl or leather |
| GR 5 | +\$259 | Grade 5 fabric, vinyl or leather |
| GR 6 | +\$327 | Grade 6 fabric, vinyl or leather |
| GR 7 | +\$402 | Grade 7 fabric, vinyl or leather |
| GR 8 | +\$482 | Grade 8 fabric, vinyl or leather |

Build Model String

 1 2 3 4 5 6 7 8 8A 7A*

Example:

330-B-01-0A-WH-9US-FA-GR A (ORIGIN JET)

*Note: Textile detail is always listed at the end.



Quoting is easiest with Via's online quote software that renders & prices your model in real time. Scan the QR code or visit <https://viaseating.com/spec-it/#/vista-ii>

Vista II

Mesh back chair & stool #312 & #313

GSA SIN# 33721





1. Starting Model

| Part # | Price | Description |
|--------|--------|-----------------|
| 312 | +\$465 | Mesh back chair |
| 313 | +\$537 | Mesh back stool |

2. Frame Finish

| Part # | Price | Description |
|--------|-------|----------------------|
| B | +\$0 | Standard matte black |
| S | +\$61 | Silver |

3. Arm

| Part # | Price | Description | |
|--------|-------|----------------------------|---|
| 0A | +\$0 | Standard armless |  |
| 32A | +\$88 | Matte black fixed loop arm |  |
| 49A | +\$88 | Matte grey fixed loop arm |  |

4. Optional Casters

| Part # | Price | Description | |
|--------|--------|--------------------------------------|---|
| WH | +\$103 | Black all floor casters ¹ |  |



Note 1: Casters only optional on chair #312.

5. Mesh

| Part # | Price | Description |
|--------|-------|-------------------------------------|
| 01V | +\$0 | Standard black |
| 02V | +\$0 | Silver |
| 03V | +\$0 | Blue |
| 04V | +\$0 | Orange |
| 05V | +\$0 | Green |
| 06V | +\$0 | Red |
| 08V | +\$0 | Coffee |
| 11V | +\$58 | Black copper |
| 12V | +\$58 | Original natural copper |
| 13V | +\$58 | Natural striped copper ² |

Note 2: #13V will release in Q1 2024.

6. Optional Ganging Brackets

| Part # | Price | Description | |
|--------|--------|---|---|
| 33GNGR | +\$100 | Unlockable latch, permanent ganging brackets ³ |  |
| 33GNGP | +\$100 | Fixed, permanent ganging brackets ³ |  |

Note 3: Ganging brackets not optional with casters.

7. Packaging

| Part # | Price | Description |
|--------|---------|---|
| FA | +\$0 | Ships fully assembled in the box |
| BW | CALL US | Ships blanket wrapped w/ minimum order quantity 150 - Call 1-800-433-6614 for pricing |

7a. Single Chair Shipment

| Part # | Price | Description |
|--------|-------|---|
| | +\$0 | Not selected / this is a multiple chair order |
| SC | +\$74 | Single chair order ⁴ |

Note 4: Upcharge only applicable to a single chair #312.

Vista II

Mesh back chair & stool #312 & #313

GSA SIN# 33721



8. Textile

| Part # | Price | Description |
|--------|--------|----------------------------------|
| GR A | +\$0 | Grade A fabric, vinyl or leather |
| GR B | +\$22 | Grade B fabric, vinyl or leather |
| GR 1 | +\$57 | Grade 1 fabric, vinyl or leather |
| COM | +\$57 | Customer's Own Fabric or Vinyl |
| GR 2 | +\$84 | Grade 2 fabric, vinyl or leather |
| GR 3 | +\$123 | Grade 3 fabric, vinyl or leather |
| COL | +\$123 | Customer's Own Leather |
| GR 4 | +\$162 | Grade 4 fabric, vinyl or leather |
| GR 5 | +\$216 | Grade 5 fabric, vinyl or leather |
| GR 6 | +\$291 | Grade 6 fabric, vinyl or leather |
| GR 7 | +\$407 | Grade 7 fabric, vinyl or leather |
| GR 8 | +\$542 | Grade 8 fabric, vinyl or leather |

Build Model String

___ - ___ - ___ - ___ - ___ - ___ - ___ - ___ - ___ - ___
1 2 3 4 5 6 7 7A 8

Example:

312-B-0A-WH-01V-FA-GR A (ORIGIN JET)

*Note: Textile detail is always listed at the end.



Quoting is easiest with Via's online quote software that renders & prices your model in real time. Scan the QR code or visit <https://viaseating.com/spec-it/#/vista-II>

Vista II

Upholstered back chair & stool #302 & #303
GSA SIN# 33721





1. Starting Model

| Part # | Price | Description |
|--------|---------------|------------------------|
| 302 | +\$515 | Upholstered back chair |
| 303 | +\$689 | Upholstered back stool |

2. Frame Finish

| Part # | Price | Description |
|--------|--------------|----------------------|
| B | +\$0 | Standard matte black |
| S | +\$61 | Silver |

3. Arm



| Part # | Price | Description |
|--------|--------------|---|
| 0A | +\$0 | Standard armless  |
| 32A | +\$88 | Matte black fixed loop arm  |
| 49A | +\$88 | Matte grey fixed loop arm  |

4. Optional Casters

| Part # | Price | Description |
|--------|---------------|--|
| WH | +\$103 | Black all floor casters ¹  |

Note 1: Casters only optional on chair #302.

5. Optional Upholstered Backshell

| Part # | Price | Description |
|--------|---------------|---|
| | +\$0 | Not selected / standard backshell is black poly  |
| 22UBF | +\$207 | Upholstered backshell for fabrics or vinyl  |
| 22UBL | +\$244 | Upholstered backshell for leather  |

6. Optional Ganging Brackets

| Part # | Price | Description |
|--------|---------------|--|
| 33GNR | +\$100 | Unlockable latch, permanent ganging brackets ²  |
| 33GNP | +\$100 | Fixed, permanent ganging brackets ²  |

Note 2: Ganging brackets not optional with casters.

7. Packaging

| Part # | Price | Description |
|--------|----------------|---|
| FA | +\$0 | Ships fully assembled in the box |
| BW | CALL US | Ships blanket wrapped w/ minimum order quantity 150 - Call 1-800-433-6614 for pricing |

7a. Single Chair Shipment

| Part # | Price | Description |
|--------|--------------|---|
| | +\$0 | Not selected / this is a multiple chair order |
| SC | +\$74 | Single chair order ³ |

Note 3: Upcharge only applicable to a single chair #302.

Vista II

Upholstered back chair & stool #302 & #303
GSA SIN# 33721



8. Upholstery Layout

| Part # | Price | Description | |
|--------|-------------|--|--|
| | +\$0 | Standard single (1) textile | |
| U2 | +\$0 | Two-tone (2 textiles): • 1 textile on seat • 1 textile on back | |

9. Textile

| Part # | Price | Description |
|--------|---------------|----------------------------------|
| GR A | +\$0 | Grade A fabric, vinyl or leather |
| GR B | +\$27 | Grade B fabric, vinyl or leather |
| GR 1 | +\$69 | Grade 1 fabric, vinyl or leather |
| COM | +\$69 | Customer's Own Fabric or Vinyl |
| GR 2 | +\$107 | Grade 2 fabric, vinyl or leather |
| GR 3 | +\$162 | Grade 3 fabric, vinyl or leather |
| COL | +\$162 | Customer's Own Leather |
| GR 4 | +\$224 | Grade 4 fabric, vinyl or leather |
| GR 5 | +\$285 | Grade 5 fabric, vinyl or leather |
| GR 6 | +\$372 | Grade 6 fabric, vinyl or leather |
| GR 7 | +\$475 | Grade 7 fabric, vinyl or leather |
| GR 8 | +\$603 | Grade 8 fabric, vinyl or leather |

Build Model String

 1 2 3 4 5 6 7 7A 8 9

Example:

302-B-0A-WH-FA-U2-GR A
(ORIGIN JET, ORIGIN ALLOY)



Quoting is easiest with Via's online quote software that renders & prices your model in real time. Scan the QR code or visit <https://viaseating.com/spec-it/#/vista-II>

Vista II

Upholstered back bariatric chair #307
GSA SIN# 33721





1. Starting Model

| Part # | Price | Description |
|--------|---------|----------------------------------|
| 307 | +\$1245 | Upholstered back bariatric chair |



2. Frame Finish

| Part # | Price | Description |
|--------|-------|----------------------|
| B | +\$0 | Standard matte black |
| S | +\$61 | Silver |

3. Arm

| Part # | Price | Description | |
|--------|-------|----------------------------|---|
| 0A | +\$0 | Standard armless |  |
| 32A | +\$88 | Matte black fixed loop arm |  |
| 49A | +\$88 | Matte grey fixed loop arm |  |



4. Optional Ganging Brackets

| Part # | Price | Description | |
|--------|--------|--|---|
| 33GNR | +\$100 | Unlockable latch, permanent ganging brackets |  |
| 33GNP | +\$100 | Fixed, permanent ganging brackets |  |

5. Packaging

| Part # | Price | Description |
|--------|---------|---|
| FA | +\$0 | Ships fully assembled in the box |
| BW | CALL US | Ships blanket wrapped w/ minimum order quantity 150 - Call 1-800-433-6614 for pricing |

6. Upholstery Layout

| Part # | Price | Description | |
|--------|-------|--|---|
| | +\$0 | Standard single (1) textile |  |
| U2 | +\$0 | Two-tone (2 textiles): • 1 textile on seat • 1 textile on back |  |

7. Textile

| Part # | Price | Description |
|--------|---------|----------------------------------|
| GR A | +\$0 | Grade A fabric, vinyl or leather |
| GR B | +\$34 | Grade B fabric, vinyl or leather |
| GR 1 | +\$119 | Grade 1 fabric, vinyl or leather |
| COM | +\$119 | Customer's Own Fabric or Vinyl |
| GR 2 | +\$169 | Grade 2 fabric, vinyl or leather |
| GR 3 | +\$252 | Grade 3 fabric, vinyl or leather |
| COL | +\$252 | Customer's Own Leather |
| GR 4 | +\$369 | Grade 4 fabric, vinyl or leather |
| GR 5 | +\$489 | Grade 5 fabric, vinyl or leather |
| GR 6 | +\$671 | Grade 6 fabric, vinyl or leather |
| GR 7 | +\$872 | Grade 7 fabric, vinyl or leather |
| GR 8 | +\$1121 | Grade 8 fabric, vinyl or leather |

Build Model String

_ _ - _ - _ - _ - _ -
 1 2 3 4 5 6 7

Example:

307-B-0A-FA-GR A (ORIGIN JET)



Quoting is easiest with Via's online quote software that renders & prices your model in real time. Scan the QR code or visit <https://viaseating.com/spec-it/#/vista-ii>

Vista II

All key specification details

#302, #303, #307, #312, #313, #330 & #331



Key Details



Quick Ship / 48-Hour Manufacturing

20 chairs/10 with upholstered backshells/5 bariatric made in 48 hours with stocked textiles. See viaseating.com/quick-ship/



Warranty

12 year warranty, 10 with casters, 6 for poly poly, 5 for mesh. See viaseating.com/warranty/

Specifications: Chairs & Stools

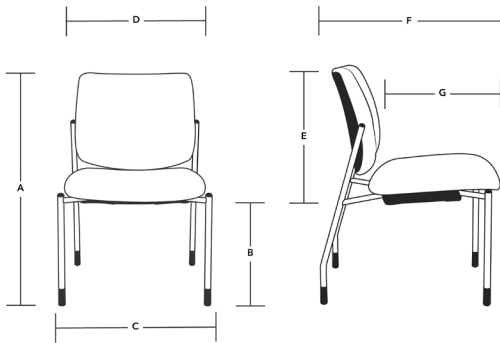

| MODEL: | 302 | | 312 | | 330 | | 307 | 303 | 313 | 331 |
|-------------------------|---------|---------|---------|---------|---------|---------|---------|---------|---------|---------|
| CASTERS?: | / | WH | / | WH | / | WH | / | / | / | / |
| Dimensions | | | | | | | | | | |
| A - Max Height | 33.0" | 33.5" | 33.0" | 33.5" | 32.5" | 33.5" | 35.5" | 43.0" | 43.0" | 43.0" |
| B - Seat to Floor | 19.5" | 20.0" | 19.5" | 20.0" | 17.5" | 18.0" | 21.5" | 29.5" | 29.5" | 27.5" |
| C - Max Width | 19.0" | 19.0" | 19.0" | 19.0" | 18.5" | 18.5" | 30.0" | 19.0" | 19.0" | 18.5" |
| D - Seat Width | 19.0" | 19.0" | 19.0" | 19.0" | 18.5" | 18.5" | 30.0" | 19.0" | 19.0" | 18.5" |
| E - Backrest Height | 17.5" | 17.5" | 17.5" | 17.5" | 17.5" | 17.5" | 17.5" | 17.5" | 17.5" | 17.5" |
| F - Max Depth | 26.0" | 26.0" | 26.0" | 26.0" | 26.0" | 26.0" | 29.0" | 26.0" | 26.0" | 26.0" |
| G - Max Seat Depth | 19.5" | 19.5" | 19.5" | 19.5" | 19.5" | 19.5" | 19.5" | 19.5" | 19.5" | 19.5" |
| Weights | | | | | | | | | | |
| Weight Capacity | 500 lb | 350 lb | 500 lb | 350 lb | 500 lb | 350 lb | 500 lb | 350 lb | 350 lb | 350 lb |
| Product Weight | 32.0 lb | 32.0 lb | 30.0 lb | 30.0 lb | 20.0 lb | 20.0 lb | 42.0 lb | 40.0 lb | 38.0 lb | 28.0 lb |
| Stacking Heights | | | | | | | | | | |
| Max on Floor | 3 | | 3 | | 3 | | 3 | 2 | 2 | 2 |

Vista II

COM/COL & key arm specification details
#302, #303, #307, #312, #313, #330 & #331



COM/COL

| MODEL: | 302 | 303 | 312/313 | 330/331 | 307 |
|------------------------------|-------------------|-------------------|-------------------|-------------------|-------------------|
| Textiles¹ | | | | | |
| Chair COM (fabric / vinyl) | 1.22 yd / 1.14 yd | 1.22 yd / 1.14 yd | / | / | 2.13 yd / 2.12 yd |
| Chair COL | 16.1 sq ft | 16.1 sq ft | / | / | 24.25 sq ft |
| Seat COM (fabric / vinyl) | 0.73 yd / 0.75 yd | 0.73 yd / 0.75 yd | 0.73 yd / 0.75 yd | 0.73 yd / 0.75 yd | 0.82 yd / 0.81 yd |
| Seat COL | 6.7 sq ft | 6.7 sq ft | 6.7 sq ft | 6.7 sq ft | 9.0 sq ft |
| Back COM | 0.75 yd | 0.75 yd | / | / | 1.5 yd |
| Back COL | 5.8 sq ft | 5.8 sq ft | / | / | 16.38 sq ft |
| #22UBF upholstered backshell | 0.75 yd | 0.75 yd | / | / | / |
| #22UBL upholstered backshell | 5.2 sq ft | 5.2 sq ft | / | / | / |
| Back w/ #22UBF | 0.75 yd | 0.75 yd | / | / | / |
| Back w/ #22UBL | 10.27 sq ft | 10.27 sq ft | / | / | / |



Need Support? COM/COL amounts are listed for a single product. We are happy to supply yardage requirement quotes for multiple (any more than 1) chair orders, as material cost savings may be realized. Please call 1-800-433-6614 or contact your CAS support at West (CSWest@viaseating.com), South (CSSouth@viaseating.com), North (CSNorth@viaseating.com) or Canada (cscanada@viaseating.com).

Specifications: Arms

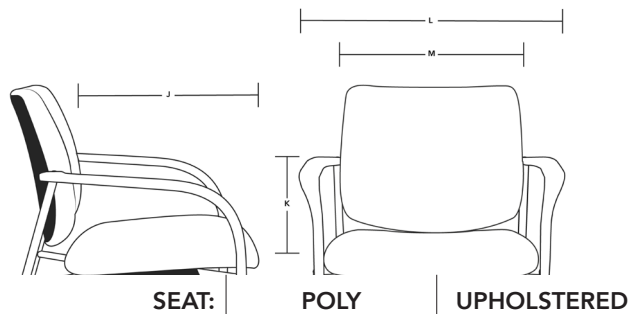

| Dimensions | POLY | UPHOLSTERED |
|----------------------------|---------|-------------|
| J - Armrest Height | 15.0" | 15.0" |
| K - Max Armrest Width | 10.0" | 8.0" |
| L - Width Between Armrests | 25.5" | 25.5" |
| M - Armrest Length | 20.5" | 20.5" |
| Weights | | |
| Product Weight | +4.0 lb | +4.0 lb |