

12C Single position knee-tilt control user guide

For use on executive single shells (back & seat connected).

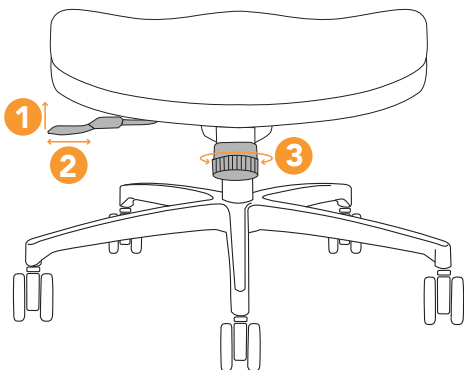

1 Seat height adjustment - Adjust the seat height by lifting your weight out of the chair and pulling up on the paddle. Proper seat height is realized when the top of your legs are somewhat parallel to the floor.

2 Back lock adjustment (single position) - Use the same paddle you use for the seat height adjustment. To lock the chair in an upright position, shift your weight forward until the chair is in an upright position, then push lever in. To rock (free float) shift your weight forward and pull the lever out.

3 Back/recline tension adjustment - Rotate knob clockwise (right) to increase tilt tension. Rotate knob counter-clockwise (left) to decrease tilt tension.



Contract Holder

contract #: GS-28F-005CA

contractor: VIA INC